

**PROGRESS REPORT ON
ARTIFICIAL INTELLIGENCE BASED LINE FOLLOWER ROBOT AT SCHOOL
LEVEL IN KUMARAM BHEEM ASIFABAD DISTRICT, TELANGANA STATE UNDER
SCHEDULED TRIBES(ST) CATEGORY UNDER ICPS PROGRAMME**

**THEME
DEMONSTRATION OF MODEL OF LATEST
TECHNOLOGY RELEVANT ROBOT AND
AI, DEVELOPMENT OF THE MODEL FOR EXPERIMENT**



सत्यमेव जयते

**SPONSORED BY
NM-ICPS DIVISION
MINISTRY OF SCIENCE & TECHNOLOGY
DEPARTMENT OF SCIENCE & TECHNOLOGY
GOVERNMENT OF INDIA**

ORGANISED BY

**BODA.NAGESWARA RAO
PROJECT INVESTIGATOR
MULTIPURPOSE AWARENESS SOCIETY
#5-198, MARKNADYA NAGAR
G.R.ROAD, IDA JEEDIMETLA,
MEDCHAL DIST, HYDERABAD – PIN 500055
TELANGANA STATE
MOBILE: 91-8985758649
email:bnrmas1@gmail.com
www.masindia.org**

PROGRESS REPORT ON
ARTIFICIAL INTELLIGENCE BASED LINE FOLLOWER ROBOT AT SCHOOL
LEVEL IN KUMARAM BHEEM ASIFABAD DISTRICT, TELANGANA STATE UNDER
SCHEDULED TRIBES(ST) CATEGORY UNDER ICPS PROGRAMME

THEME
DEMONSTRATION OF MODEL OF LATEST
TECHNOLOGY RELEVANT ROBOT AND
AI, DEVELOPMENT OF THE MODEL FOR EXPERIMENT



सत्यमेव जयते

SPONSORED BY
NM-ICPS DIVISION
MINISTRY OF SCIENCE & TECHNOLOGY
DEPARTMENT OF SCIENCE & TECHNOLOGY
GOVERNMENT OF INDIA

ORGANISED BY
BODA.NAGESWARA RAO
PROJECT INVESTIGATOR
MULTIPURPOSE AWARENESS SOCIETY
#5-198, MARKNADYA NAGAR
G.R.ROAD, IDA JEEDIMETLA,
MEDCHAL DIST, HYDERABAD – PIN 500055
TELANGANA STATE
MOBILE: 91-8985758649
email:bnrmas1@gmail.com
www.masindia.org



MULTIPURPOSE AWARENESS SOCIETY

మల్టీపర్పస్ అవేర్నెస్ సొసైటీ

Regd. No.1016/2011, dt.03.11.2011(N.G.O)

BODA NAGESWARA RAO
PRESIDENT

Date: 01/10/2019

SCHOOL AWARENESS PROGRAMME

ARTIFICIAL INTELLIGENCE BASED LINE FOLLOWER ROBOT

AT

**SCHOOL LEVEL IN KUMARAM BHEEM ASIFABAD DISTRICT, TELANGANA STATE
UNDER SCHEDULED TRIBE (ST) CATEGORY UNDER ICPS PROGRAMME.**

(PROGRAMS DURATION: FROM 01.04.2019 TO 30.09.2019)

State	District	Schools	Date of Started	Dated of Completion	No. of Students Trained	No. of Teachers Trained	No. of Gadget/Posters etc.	Gadget Usage Statistics	Photos, Videos etc.
Telangana State	Komaram Bheem Asifabad District	100 Schools	06.06.19	30.09.2019	10005	205	230 project kits 1400 posters	10005 Students	Enclosed Progress Report

- 1.Number of School Targeted :100
- 2.Number of School Achieved: 132
3. Complementary Programs conducted in Number of Schools = 32
4. Total Project Kits Distributed:230.Nos



FOR MULTIPURPOSE AWARENESS SOCIETY

Brucey
PRESIDENT

CONTENTS

S NO	Description	Page No
01	Report Chart: School Awareness of Komaram Bheem Asifabad District	04 to 14
02	About Kumuram Bheem (Asifabad Distrct)	15 to 27
03	Artificial Intelligence Based Line Follower Robot Project Details (Introduction)	28 to 30
04	Artificial Intelligence Based Line Follower Robot Project Details Applications	31 to 32
05	Circuit & Block Diagram	33 to 36
06	Interdisciplinary Cybar- Physical Systems (ICPS) Applications	37 to 41
07	Artificial Intelligence Based Line Follower Robot For Rural School Students In Komaram Bheem Asifabad District TS. Project Demonstration And School Experiment Activities certificates Of 100 Schools	42 to 92
08	Artificial Intelligence Based Line Follower Robot For Rural School Students In Komaram Bheem Asifabad District TS. Project Demonstration And School Experiment Activities Photos	93 to 103
09	References	104 to 104



Report Chart: School Awareness of Komaram Bheem Asifabad District

S.No	Date	Programs Location	Mandal Name	Project kits	Posters	No's of Students	Certificate issued
1	06.06.2019	GOVT JR COLLEGE KOUTALA KOMURAMBHEEM ASIFABAD DIST	KOUTALA MANDAL	1	12	20	-
2	19.06.2019	ZPSS SCHOOL KOUTALA KOMURAMBHEEM ASIFABAD	KOUTALA MANDAL	1	10	50	50
3	04.07.2019	K.G.B.V Koutala Mandal Kumaram Bheem Asifabad District	Koutala Mandal	1	16	50	50
4	04.07.2019	Infant Jesus E/M School Kumaram Bheem Asifabad district	Koutala Mandal	1	9	50	50
5	04.07.2019	Govt AHS Mogad Dhagad Koutala Mandal Kumaram Bheem Asifabad district	Koutala Mandal	1	10	40	40
6	05.07.2019	Z.P.H.S. Muthampet Kumaram Bheem Asifabad district	Koutala Mandal	1	10	60	60
7	05.07.2019	Eden Garden High School Sirpur -T Mandal Kumaram Bheem Asifabad district	Sirpur -T Mandal	1	11	50	50
8	05.07.2019	Z.P.H.S.Sirpur-T Kumaram Bheem Asifabad district	Sirpur -T Mandal	1	15	30	30
9	06.07.2019	Z.P.S.S. Bodampally Mandal Kumaram Bheem Asifabad district	Bodampally Mandal	1	10	41	41
10	06.07.2019	Z.P.S.S. DABBA, Chinthalamanepally Mandal Kumaram Bheem Asifabad district	Chinthalamanepally Mandal	1	12	55	55
11	07.07.2019	TSWRS & JC(Boys) Kumaram Bheem Asifabad district	Sirpur-T	1	12	45	45

12	07.07.2019	TSWRS (Girls) Sirpur-T Kumaram Bheem Asifabad district	Sirpur-T	1	15	60	60
13	18.07.2019	KG BV School Kumaram Bheem Asifabad district	Chintalamanepally	1	12	45	45
14	18.07.2019	Govt AHS (G) Babapur Kumaram Bheem Asifabad district	Chintalamanepally	1	10	44	44
15	18.07.2019	Govt High School Babanagar Kumaram Bheem Asifabad district	Chintalamanepally	1	14	52	52
16	18.07.2019	Z.P.H.S.Gangapur Kumaram Bheem Asifabad district	Chintalamanepally	1	10	37	37
17	19.07.2019	UPS Rudrapur Kumaram Bheem Asifabad district	Bujipur	1	9	20	20
18	19.07.2019	Z.P.S.S. Babasagar Kumaram Bheem Asifabad district	Chintalamanepally	1	10	70	70
19	19.07.2019	Z.P.S.S. Chintalamanepally Kumaram Bheem Asifabad district	Chintalamanepally	1	14	38	38
20	19.07.2019	Govt AHS Salugupally Kumaram Bheem Asifabad district	Salugupally	1	14	80	50
21	20.07.2019	Z.P.S.S.Bejjur Kumaram Bheem Asifabad district	Bejjur	1	15	85	85
22	20.07.2019	M.P.U.P.S.Bareguda Kumaram Bheem Asifabad district	Bejjur	1	16	23	23
23	20.07.2019	Z.P.S.S. Salugupally Kumaram Bheem Asifabad district	Bejjur	1	13	70	70
24	22.07.2019	K.G.B.V School Kumaram Bheem Asifabad district	Bejjur	1	15	85	85
25	22.07.2019	Govt Ashram School Kumaram Bheem Asifabad district	Bejjur	1	15	82	82
26	22.07.2019	Govt AHS Kethini Boys Kumaram Bheem Asifabad district	Chintalamanepally	1	18	38	38
27	23.07.2019	Govt A.H.S.Bejjur Kumaram Bheem Asifabad district	Bejjur	1	12	45	45
28	25.07.2019	M.P.P.S Dadanaagr Kumaram Bheem Asifabad district	Kaghaznagar	1	12	28	28
29	25.07.2019	M.P.P.S.Kosini Kumaram Bheem Asifabad District	Kaghaznagar	1	10	85	85

30	26.07.2019	Jawahar Navodaya Vidyala Bheem Kumaram Asifabad District	Sirpur-Kaghnaznagar	1	12	240	240
31	27.07.2019	Z.P.S.S.(G) Sirsilk Kumaram Bheem Asifabad District	Kaghnaznagar	1	15	62	62
32	27.07.2019	k.G.B.V R Kumaram Bheem Asifabad District	Kaghnaznagar	2	10	198	198
33	27.07.2019	Govt Ashram High School Kumaram Bheem Asifabad District	Kaghnaznagar	2	12	218	218
34	29.07.2019	T.T.W.U.R.J.C.GIRLS Sirpur-T Bheem Kumaram Asifabad District	Sirpur-T	2	10	280	280
35	30.07.2019	Z.P.S.S(B) Sirailk Kaghnaznagar Bheem Kumaram Asifabad Dist	Kaghnaznagar	2	15	265	265
36	31.07.2019	Z.P.S.S Vempally Kaghnaznagar Bheem Kumaram Asifabad Dist	Sirpur-T	2	15	100	100
37	01.08.2019	M.P.U.P.S. Easgan Kaghnaznagar Bheem Kumaram Asifabad Dist	Kaghnaznagar	2	16	151	151
38	01.08.2019	Z.P.S.S(B) Sirailk Kaghnaznagar Bheem Kaghnaznagar Kumaram Asifabad Dist	Kaghnaznagar	2	16	145	145
39	01.08.2019	Govt .P.S. Sirailk Kaghnaznagar Bheem Kaghnaznagar Kumaram Asifabad Dist	Kaghnaznagar	2	12	127	127
40	01.08.2019	Z.P.S.S Chinthagud Kaghnaznagar Bheem Kumaram Asifabad Dist	Kaghnaznagar	1	12	150	150
41	01.08.2019	Govt High School Easgaon No.3 Kaghnaznagar Bheem Kumaram Asifabad Dist	Kaghnaznagar	2	20	306	306
42	01.08.2019	Govt High School (Old) Sirpur-Kaghnaznagar Bheem Kumaram Asifabad Dist	Kaghnaznagar	2	10	300	306
43	01.08.2019	Z.P.S.S.Petrol Pump	Kaghnaznagar	1	11	250	250

		Kaghaznagar Kumaram Bheem Asifabad Dist					
44	01.08.2019	Govt High School (NEW) RR O Clooney Sirpur-Kaghaznagar Kumaram Bheem Asifabad Dist	Kaghaznagar	1	13	127	127
45	03.08.2019	M.P.P.S Bodampally Koutala Kumaram Bheem Asifabad Dist	koutala	1	12	148	148
46	03.08.2019	M.P.P. Talodi Koutala Kumaram Bheem Asifabad Dist	Koutala	1	16	30	30
47	05.08.2019	TWDISHA MODEL SCHOOL GURUDUPETA KOUTALA KOMURAMASIFABAD DIST	KOUTALA	1	15	130	130
48	05.08.2019	ZPSS GUNDAIPET KOUTALA KOMURAMBHEEM ASIFABAD	KOUTALA	1	10	53	53
49	05.08.2019	MPPS IPPALAGUDA KOUTALA KOMURAMBHEEM ASIFABAD	KOUTALA	1	20	29	29
50	05.08.2019	TWPS SHIVALINGAPUR KOUTALA KOMURAMBHEEM ASIFABAD	KOUTALA	2	10	111	111
51	05.08.2019	MPPS GUNDAIPET KOUTALA KOMURAMBHEEM ASIFABAD	KOUTALA	1	12	140	140
52	06.08.2019	MPUPS KANNEPALLI KOUTALA KOMURAMBHEEM ASIFABAD	KOUTALA	1	9	42	42
53	06.08.2019	MPUPS GUDLABORI KOUTALA KOMURAMBHEEM ASIFABAD	KOUTALA	1	15	35	35
54	06.08.2019	GOVT.ASH MOGAD DAGAD KOUTALA KOMURAMBHEEM ASIFABAD	KOUTALA	2	8	180	180
55	06.08.2019	ZPSS LONAVELLY SIRPUR T KOMURAMBHEEM ASIFABAD	SIRPUR T	1	12	35	35

56	06.08.2019	TWPS K B COLANY MOGAD DAGAD KOMUTALA KOMURAMBHEEM ASIFABAD	KOUTALA	2	14	122	122
57	06.08.2019	TSWRES KAGAZNAGAR GIRLS SIRPUR T KOMURAMBHEEM ASIFABAD	SIRPUR T	1	15	50	50
58	07.08.2019	MPPS PARDI KOUTALA KOMURAMBHEEM ASIFABAD	KOUTALA	1	12	48	48
59	07.08.2019	MPUPS GOPALAPATNAM SIRPUR T KOMURAMBHEEM ASIFABAD	SIRPUR T	1	16	80	80
60	07.08.2019	MPUPS MOGAD DAGAD KOUTALA KOMURAMBHEEM ASIFABAD	KOUTALA	1	14	145	145
61	07.08.2019	MPPS SHIRSHA KOUTALA KOMURAMBHEEM ASIFABAD	KOUTALA	1	15	50	50
62	07.08.2019	MPUPS VIRDHANDI KOUTALA KOMURAMBHEEM ASIFABAD	KOUTALA	1	12	69	69
63	07.08.2019	MPPS SIDHAPUR KOUTALA KOMURAMBHEEM ASIFABAD	KOUTALA	1	20	53	53
64	07.08.2019	MPPS PATHAKANNAPALLY KOUTALA KOMURAMBHEEM ASIFABAD	KOUTALA	2	10	109	109
65	07.08.2019	MPPS KUMBARI KOUTALA KOMURAMBHEEM ASIFABAD	KOUTALA	1	9	119	119
66	07.08.2019	MPPS BHEEVERHETI KOUTALA KOMURAMBHEEM ASIFABAD	KOUTALA	2	18	114	114
67	07.08.2019	MPPS VAIGAM KOUTALA KOMURAMBHEEM ASIFABAD	KOUTALA	2	15	104	104
68	07.08.2019	MPPS GATTUGUDA KOUTALA KOMURAMBHEEM ASIFABAD	KOUTALA	1	17	30	30
69	08.08.2019	BALA BHARATHI HIGHT SCHOOL WARD NO.11 SBI BANK KAGAZNAGAR KOMURAMBHEEM ASIFABAD	KAGAZNAGAR	1	12	25	25
70	08.08.2019	ZPSS BOYS SIRSIK KAGAZNAGAR	KAGAZNAGAR	1	15	91	91

		KOMURAMBHEEM ASIFABAD					
71	08.08.2019	MPPS SADHASHIVPET KOUTALA KOMURAMBHEEM ASIFABAD	KOUTALA	1	12	73	73
72	08.08.2019	KGBV SIRPUR T KOMURAMBHEEM ASIFABAD	SIRPUR T	1	15	70	70
73	08.08.2019	MPPS KANIKI KOUTALA KOMURAMBHEEM ASIFABAD	KOUTALA	2	8	35	35
74	08.08.2019	MPPS THUMDI THUMDIHETTI KOUTALA KOMURAMBHEEM ASIFABAD	KOUTALA	1	10	73	73
75	08.08.2019	MPPS KOYAGUDAM KOUTALA KOMURAMBHEEM ASIFABAD	KOUTALA	1	15	40	40
76	08.08.2019	MPUPS KOUTI KOUTALA KOMURAMBHEEM ASIFABAD	KOUTALA	1	15	62	62
77	08.08.2019	TWPS PATELGUDA VIRDANDI KOUTALA KOMURAMBHEEM ASIFABAD	KOUTALA	2	16	130	130
78	08.08.2019	TWPS DHANURHETTI TALODI KOUTALA KOMURAMBHEEM ASIFABAD	KOUTALA	1	10	70	70
79	20-08-2019	SISHU MANDIR HIGH SCHOOL KAGAZNAGAR KOMRAMBHEEM ASIFABAD	KAGAZNAGAR	1	9	90	90
80	20-08-2019	GOVT PRIMARY RB URDU LBS MARKET SIRSILK COLONY	SIRSILK	2	11	35	35
81	20-08-2019	GOVT HIGH SCHOOL RB URDU SIRSILK COLONY	SIRPUR KAGAZNAGAR	1	12	21	21
82	21-08-2019	SREE VANI VIDYALAYAM CHINTHAGUDA KAGAZNAGAR KOMRAMBHEEM ASIFABAD	KAGAZNAGAR	1	14	30	30
83	21-08-2019	MPPS URDU KOYAVAGU KAGAZNAGAR KOMRAMBHEEM ASIFABAD	KAGAZNAGAR	1	14	35	35

84	21-08-2019	MPPS GIRLS NEAR BUS STAND ASIFABAD	ASIFABAD	1	15	50	50
85	21-08-2019	MC GUFFEY EM SCHOOL SIRSILK CHOWK KAGAZNAGAR KOMRAMBHEEM ASIFABAD	KAGAZNAGAR	2	8	100	100
86	21-08-2019	CHAITANYA VIDYA MANDIR CHINTHAGUDA KAGAZNAGAR KOMRAMBHEEM ASIFABAD	KAGAZNAGAR	1	13	30	30
87	22-08-2019	SREE VISHWA SHANTHI HIGH SCHOOL PETROL PUMP KAGAZNAGAR	KAGAZNAGAR	2	10	100	100
88	23-08-2019	MPPS WARD NO. 13 KAGAZNAGAR KOMRAMBHEEM ASIFABAD	KAGAZNAGR	1	8	50	50
89	23-08-2019	GOVT PS GANGARAM BASTHI SIRPUR KAGAZNAGAR KOMRAMBHEEM ASIFABAD	KAGAZNAGAR	2	18	36	36
90	23-08-2019	GOVT MPPS HARIJANVADA SIRPIR KOMRAMBHEEM ASIFABAD	SIRPUR	1	8	25	25
91	23-08-2019	GOVT PS OLD RRO COLONY SIRPUR KOMRAMBHEEM ASIFABAD	SIRPUR	2	16	41	41
92	23-08-2019	MPPS KAPUWADA SIRPUR KGZNGR KOMRAMBHEEM ASIFABAD	SIRPUR	1	9	25	25
93	26-08-2019	GOVT UPS WARD NO. 14 SIRPUR KGNGR KOMRAMBHEEM ASIFABAD	SIRPUR KAGAZNAGAR	2	12	35	35

94	26-08-2019	MPPS WARD NO. 5 SIRPUR KAGAZNAGAR KOMRAMBHEEM ASIFABAD	SIRPUR KAGAZNAGAR	2	15	36	36
95	26-08-2019	VIDHYADHARI HIGH SCHOOL SRINAGAR COLONY KAGAZNAGAR KOMRAMBHEEM ASIFABAD	KAGAZNAGAR	2	18	12	12
96	26-08-2019	MPPPS PETROLPUMP WARD NO. 22 KAGAZNAGAR KOMRAMBHEEM ASIFABAD	KAGAZNAGAR	1	19	63	63
97	26-08-2019	MPPS NANDIGUDA KAGAZNAGAR KOMRAMBHEEM ASIFABAD	KAGAZNAGAR	4	17	20	20
98	27-08-2019	ZPSS GIRLS RAJIV NAGAR ASIFABAD	ASIFABAD	2	10	130	130
99	27-08-2019	GOVT PS KAGAZNAGAR KOMRAMBHEEM ASIFABAD	KAGAZNAGAR	1	18	30	30
100	27-08-2019	MPPS URDU OPP GOVT HOSPITAL ASIFABAD	ASIFABAD	4	19	42	42

Project Team

01. B. Nageshwar Rao B.Tech, M.B.A
02. B. Suresh B. Tech, Computer Science Engineering
03. Ch. Krupasagar Diploma in Robotic Engineering
04. B. Nagesh Inter
05. G. Krishna B.Tech Electronics Communication Engineering

Complementary Work from Multipurpose Awareness Society

S.No	Date	Programs Location	Mandal Name	Project kits	Posters	No's of Students	Certificate issued
101	27-08-2019	GOVT ASHRAM SCHOOL BOYS OPP FOREST OFFICE ASIFABAD	ASIFABAD	-	9	30	30
102	27-08-2019	ZPSS BOYS OPP DSP OFFICE ASIFABAD	ASIFABAD	-	8	120	120
103	27-08-2019	TSWRS/TC BOYS OPP FOREST OFFICE JANKAPUR ASIFABAD	ASIFABAD	-	10	240	240
104	27-08-2019	ZPSS JANKAPUR ASIFABAD	ASIFABAD	-	3	120	120
105	28-08-2019	MPPS OOTPALLY KAGAZNAGAR KOMRAMBHEEM ASIFABAD	KAGAZNAGAR	-	4	25	25
106	28-08-2019	GOVT AHS BOYS SIRPUR.T KOMRAMBHEEM ASIFABAD	SIRPUR.T	-	10	38	38
107	28-08-2019	MPPS SOANPET SIRPUR.T KOMRAMBHEEM ASIFABAD	SIRPUR.T	-	4	31	31
108	28-08-2019	MPPS GIRLS SIRPUR.T NEAR POST OFFICE SIRPUR.T KOMRAMBHEEM ASIFABAD	SIRPUR.T	-	4	46	46
109	28-08-2019	MPUPS GIRLS U/M SIRPUR.T KOMRAMBHEEM ASIFABAD	SIRPUR.T	-	8	29	29
110	28-08-2019	MPPS SOANPET U/M SIRPUR.T KOMRAMBHEEM SIFABAD	SIRPUR.T	-	7	78	78
111	28-08-2019	GOVT ASHRAM HIGH SCHOOL GIRLS SIRPUR.T KOMRAMBHEEM ASIFABAD	SIRPUR.T	-	5	382	382
112	29-08-2019	MPPS WALLAKONDA KAGAZNAGAR KOMRAMBHEEM ASIFABAD	KAGAZNAGAR	-	4	32	32
113	29-08-2019	MPPS GANDHI NAGAR SIRPUR KAGZNGR KOMRAMBHEEM ASIFABAD	KAGAZNAGAR	-	8	26	26

114	29-08-2019	MPPS GOLLAGUDA SIRPUR KAGAZNAGAR KOMRAMBHEEM ASIFABAD	KAGAZNAGAR	-	6	25	25
115	29-08-2019	MPPS GANNARAM SIRPUR KAGAZNAGAR KOMRAMBHEEM ASIFABAD	KAGAZNAGAR	-	4	25	25
116	29-08-2019	MPPS MALA SEETHA NAGAR SIRPUR KAGAZNAGAR KOMRAMBHEEM ASIFABAD	SIRPUR KAGAZNAGR	-	5	26	26
117	29-08-2019	MPPS SHIVAPUR SIRPUR KAGAZNAGAR KOMRAMBHEEM ASIFABAD	KAGAZNAGAR	-	7	34	34
118	29-08-2019	MPPS BALAGUDA KAGAZNAGAR KOMRAMBHEEM ASIFABAD	KAGAZNAGAR	-	4	28	28
119	29-08-2019	MPPS DURGAIAH WADA KAGAZNAGAR KOMRAMBHEEM ASIFABAD	KAGAZNAGAR	-	9	24	24
120	29-08-2019	MPPPS AREGODA SIRPUR KAGAZNAGAR KOMRAMBHEEM ASIFABAD	SIRPUR KAGAZNAGAR	-	10	28	28
121	29-08-2019	MPUPS BAREGUDA SIRPUR KAGAZNAGAR KOMRAMBHEEM ASIFABAD	SIRPUR KAGAZNAGAR	-	5	35	35
122	29-08-2019	MPPS JAMBUGA SIRPUR KAGAZNAGAR KOMRAMBHEEM ASIFABAD	SIRPUR KAGAZNAGAR	-	9	38	38
123	29-08-2019	MPPS NAGAMPET SIRPUR KAGAZNAGAR KOMRAMBHEEM ASIFABAD	SIRPUR KAGAZNAGAR	-	8	14	14

124	30-08-2019	MPPS BODEPALLI SIRPUR KAGAZNAGAR KOMRAMBHEEM ASIFABAD	SIRPUR KAGAZNAGAR	-	8	16	16
125	30-08-2019	MPPS JEEDICHENU SIRPUR KAGAZNAGAR KOMRAMBHEEM ASIFABAD	SIRPUR KAGAZNAGR	-	6	21	21
126	30-08-2019	MPPS KOYAWAGU SIRPUR KAGAZNAGAR KOMRAMBHEEM ASIFABAD	SIRPUR KAGAZNAGAR	-	10	28	28
127	30-08-2019	MPPS CHINTHAGUDA SIRPUR KAGAZNAGAR KOMRAMBHEEM ASIFABAD	SIRPUR KAGAZNAGAR	-	4	32	32
128	30-08-2019	MPPS NARAPUR SIRPUR KAGAZNAGAR KOMRAMBHEEM ASIFABAD	SIRPUR KAGAZNAGAR	-	4	27	27
129	30-08-2019	MPPS JAGANNATHPUR SIRPUR KAGAZNAGAR KOMRAMBHEEM ASIFABAD	SIRPUR KAGAZNAGAR	-	7	15	15
130	30-08-2019	MPUPS ANKUSAPUR SIRPUR KAGAZNAGAR KOMRAMBHEEM ASIFABAD	SIRPUR KAGAZNAGAR	-	3	20	20
131	30-08-2019	MPPS JAVVAJIGUDA SIRPUR KAGAZNAGAR KOMRAMBHEEM ASIFABAD	SIRPUR KAGAZNAGAR	-	8	11	11
132	30-08-2019	MPPS GAJJIGUDA SIRPUR KAGAZNAGAR KOMRAMBHEEM ASIFABAD	SIRPUR KAGAZNAGAR	-	4	33	33

1. About Kumuram Bheem (Asifabad District)

Kumuram Bheem District is carved out of erstwhile Adilabad District. It is surrounded by Adilabad, Mancherial, Nirmal districts and the Maharashtra state. Kumuram Bheem is being renamed as Komaram Bheem district after the legendary Gond martyr who was born in Ravte Sankepalli village near Kumuram Bheem.

Kumuram Bheem comprises 15 mandals and has two revenue divisions – Kumuram Bheem and Kaghaznagar. The district headquarter is located at Kumuram Bheem, a predominantly tribal town.

The railway line that connects the south and the north of India passes through Kumuram Bheem district. Sirpur-Kaghaznagar is a major railway station in the district. It has one RTC depot at Kumuram Bheem.

The district's primary crops include rice, cotton and pulses. Singareni Collieries, Sirpur Paper Mills, many spinning and ginning mills form the industrial profile of the district.

Historically, the district had a glorious past. Kumuram Bheem was an important part in the scheme of things of its erstwhile rulers. Fossils of the pre-historic period excavated in and around Kumuram Bheem attach archeological importance to this place. Vatti Vaagu project, Gangapur Cave, Movvad village are some of the tourist attractions. Vatti Vagu project is a medium Irrigation project being constructed across Vatt Vaagu, a tributary of Pedda Vaagu which is in turn a tributary of Pranahita river in Godavari basin.

2. Brief:

- Revenue Division : 2
- Revenue Mandals : 15
- Revenue Villages : 436
- Geographical area : 4367.25 Sq. Kms

History: Kumram Bheem (22 October 1901 – 8 October 1940) was a tribal leader who fought for the rights of tribals over jal (water), jungle (forest) and zameen (land).

* Telangana chief minister K Chandrasekhar Rao announced that Adilabad district will be bifurcated and the new district will be named after tribal leader Kumram Bheem. Addressing a public meeting on the occasion of the 74th death anniversary of Kumram Bheem at Jodeghat in the district, KCR said the hillock in the village, where the leader died fighting the Nizam's forces, will be developed into a tourist spot. He said the government will build a memorial at a cost of Rs 25 crore on 100 acres. The memorial will be ready within a year.

3. Tourist places

- Ganagapur Temple in Rebbena Mandal.
- Jodeghat village in Kerameri Mandal .
- Sapthagunda Water Falls in Sirpur- U Mandal .
- Pittaguda Water Falls, Mitte Water falls in Lingapur Mandal.
- Sri Kumram Bheem Project, Ada, Kumuram Bheem Mandal.
- Vattivagu Project, Chirrakunta, Kumuram Bheem Mandal.
- Samithulagundam waterfalls, Movad, Kumuram Bheem Mandal .
- Tonkini Temple at Sirpur-T mandal.

KOMARAM BHEEM-ASIFABAD



ADMINISTRATIVE MAP KOMARAMBHEEM ASIFABAD DISTRICT Telangana State

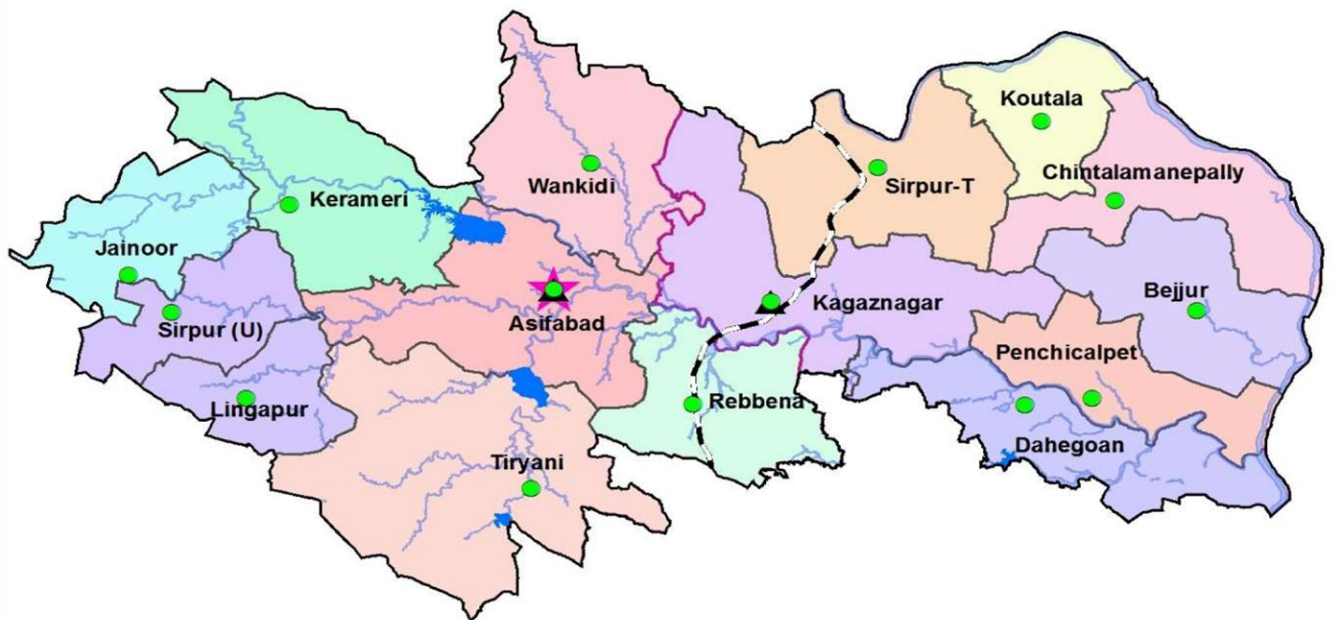

Legend

- ▲ Revenue Division Headquarters
- Mandal Headquarters
- ★ District Headquarters
- National Highway
- Railwayline
- Revenue Division Boundary
- Mandal Boundary
- Reservoir
- River



Government of Telangana
Planning Department
December, 2016

Komaram Bheem-Asifabad District

Sl. No	Parameters	State	Komaram Bheem
I	KEY CHARACTERISTICS		
1	Geographical Area (Sq. Kms.)	112077	4878
2	Administrative Units		
a	Revenue Villages	10859	431
b	Revenue Mandals	584	15
c	Revenue Divisions	68	2
d	Gram Panchayats	8695	173
e	Mandal Praja Parishads	438	12
f	Zilla Praja Parishads	9	0
g	Municipalities (incl. Corpns. & NPs)	73	1
II	DEMOGRAPHIC PROFILE		
1	Population as per 2011 Census		
	Total	35003674	515812
a	Males	17611633	258197
b	Females	17392041	257615
c	Sex Ratio (Females per 1000 Males)	988	998
d	Rural	21395009	428828
e	Urban	13608665	86984
f	Rural Population (%)	61.12	83.14
g	Urban Population (%)	38.88	16.86
2	Households	8303612	120420
3	Density of Population (per Sq. Km.)	312	106
4	Child Population (0 - 6 Years)		
	Total	3899166	66206
a	Males	2017935	34053
b	Females	1881231	32153
c	Rural	2369374	57146
d	Urban	1529792	9060
e	Sex Ratio (Females per 1000 Males)	932	944
5	Literates		
	Total	20696778	255002
a	Males	11701729	147911
b	Females	8995049	107091
6	Literacy Rate		
	Total	66.54	56.72
a	Males	75.04	65.99
b	Females	57.99	47.50

Sl. No	Parameters	State	Komaram Bheem
7	Scheduled Castes Population		
	Total	5408800	81596
a	Males	2693127	41132
b	Females	2715673	40464
c	Sex Ratio	1008	984
8	Scheduled Tribes Population		
	Total	3177940	133627
a	Males	1607656	65866
b	Females	1570284	67761
c	Sex Ratio	977	1029
9	Working Population		
	Total	16341942	253001
a	Males	9678177	142935
b	Females	6663765	110066
10	Occupation of Working Population		
a	Cultivators		
	Total	3151389	88045
	i. Males	2009546	61173
	ii. Females	1141843	26872
b	Agricultural Labourers		
	Total	5915151	99667
	i. Males	2532735	36909
	ii. Females	3382416	62758
c	Household Industries		
	Total	776529	7490
	i. Males	271767	2819
	ii. Females	504762	4671
d	Other Workers		
	Total	6498873	57799
	i. Males	4864129	42034
	ii. Females	1634744	15765
e	Non-Working		
	Total	18661732	262811
	i. Males	7933456	115262
	ii. Females	10728276	147549
11	Population as per Samagra Kutumba Survey (SKS)		
a	Households	10395629	147606
b	Total Population	36876544	539579

Sl. No	Parameters	State	Komaram Bheem
c	Scheduled Castes	6444584	86829
d	Scheduled Tribes	3644453	159817
e	Backward Castes	18841009	235205
f	Others	7946498	57728
12	Minorities Population	5372197	49304
III	AGRICULTURE		
1	Land Holdings		
a	Marginal (up to 1 Hect.)	3420202	37374
b	Small (1-2 Hects.)	1318390	28260
c	Semi-Medium (2-4 Hects.)	598145	24321
d	Medium (4-10 Hects.)	165127	6819
e	Large (10 Hects. and above)	15647	589
	Total	5517511	97363
2	Cropped Area (Hects.)		
a	Gross Cropped Area	4893148	149654
b	Net Cropped Area	4174532	127432
c	Gross Irrigated Area	2027663	11755
d	Net Irrigated Area	1486241	11755
3	Area under different Crops (Hects.)		
a	Rice	1471710	8301
b	Jowar	83401	3417
c	Maize	712981	1250
d	Red gram	251121	6413
e	Green gram	95524	985
f	Black gram	31221	131
g	Bengal gram	80766	1517
h	Groundnut	177914	29
i	Sunflower	17574	44
j	Chillies	82649	422
k	Sugarcane	34775	0
l	Cotton	1677492	28271
m	Horticulture	664326	4351
4	Agricultural Marketing		
a	Agricultural Market Committees	180	3
b	Rythu Bazars	36	0
5	Livestock Population		
a	Cattle	4880293	277680
b	Buffaloes	4160419	47262

Sl. No	Parameters	State	Komaram Bheem
c	Sheep	12835761	83813
d	Goat	4575695	184203
e	Others	620723	1305
	Total	27072891	594263
6	Poultry Population	80750833	417386
7	Veterinary facilities		
a	Poly Clinics	8	0
b	Hospitals	100	2
c	Dispensaries	907	19
d	Mobile Clinics	37	0
e	Rural Livestock Units	1102	7
8	Fisheries		
a	Fish Rearing Tanks/Reservoirs	24294	488
	Water spread Area (Hects.)	800269	11538
b	Fishermen Coop. Societies	3867	14
	Members	265071	854
c	Seed released into Tanks/Reservoirs by Govt.	3824	35
	Seed Released (lakh Nos.)	2616	18.23
d	Estimated Production, 2016-17 (Tonnes)	343447	4165
	i. Fish	334952	4065
	ii. Prawn	8495	100
IV	HEALTH INFRASTRUCTURE (GOVT.)		
1	Allopathic Hospitals		
a	Health Sub-Centres	4797	109
b	Primary Health Centres	683	18
c	Community Health Centres	98	2
d	Area Hospitals	31	0
e	District Hospitals	6	0
f	Teaching Hospitals	18	0
	Total	5633	129
2	Ayurveda Hospitals (incl. Dispensaries)	272	6
3	Homeopathic Hospitals (incl. Dispensaries)	130	2
4	Unani Hospitals (incl. Dispensaries)	141	3
5	Naturopathy Hospitals (incl. Dispensaries)	24	0
6	Doctors in all Hospitals	2595	46
7	Beds in all Hospitals	20389	148
V	EDUCATION		
a	Primary Schools	21947	905

Sl. No	Parameters	State	Komaram Bheem
	Enrollment	1431438	29916
b	Upper Primary Schools	7311	171
	Enrollment	939109	20276
c	High Schools	11803	150
	Enrollment	3689461	43416
	Total Schools	41061	1226
	Total Enrollment	6060008	93608
d	Model Schools	192	1
	Enrollment	85687	475
e	KGBV Schools	391	12
	Enrollment	72583	2259
f	Central Schools	47	1
	Enrollment	27294	400
g	Junior Colleges	2537	23
h	Degree Colleges	1196	10
	Seats	426964	2545
i	Engineering Colleges	219	0
	Seats	104598	0
j	Pharmacy Colleges	123	0
	Seats	9226	0
k	MBA Colleges	305	0
	Seats	32874	0
l	MCA Colleges	37	0
	Seats	2436	0
m	B.Ed. Colleges	217	2
	Seats	19100	150
n	Law Colleges	21	0
	Seats	3190	0
VI	SOCIAL SECURITY		
1	Aasara Pensions		
a	Old Age	1341680	20141
b	Disabled	457087	6469
c	Widow	1326049	19400
d	Weavers	34179	451
e	Toddy Tappers	57349	104
f	Anti-Retroviral Therapy (A.R.T) Patients	30674	0
	Total	3247018	46565
2	FA to Beedi Workers	348763	46

Sl. No	Parameters	State	Komaram Bheem
3	Public Distribution System		
a	Fair Price Shops	17229	280
b	Food Security Cards	8207431	125027
c	Anthyodaya Food Security Cards	567911	12272
d	Annapoorna Cards	5084	23
	Total	8797655	137602
4	Sada Bainama Regularization		
a	Applications Received	1119203	4223
b	Survey Numbers Covered	1563124	4783
5	2BHK Housing Programme		
a	Houses Allotted	72596	750
	i. Rural	39762	590
	ii. Urban	32834	160
b	Sanctioned	62426	750
6	Assignment of Government Land		
a	Land Assigned (Acres)	2040320	183017
b	Beneficiaries	1332127	61409
VII	POWER		
1	Sub-Stations		
a	33/11 KV	2497	32
b	132/33 KV	203	2
c	220/132 KV	66	0
d	400/220 KV	7	0
	Total	2773	34
2	Electricity Connections		
a	Domestic Connections	9504305	101064
b	Industrial Connections	145707	484
c	Agriculture Connections	2080706	6672
d	Commercial Connections	1171991	6332
e	Other Connections	189046	2950
	Total	13091755	117502
VIII	ROAD INFRASTRUCTURE		
1	Roads & Buildings Department (Length in Kms.)		
	i. State Highways	2731	80
	ii. Major District Roads	13058	652
	iii. Rural Roads	9162	297
	Total	24950	1030

Sl. No	Parameters	State	Komaram Bheem
	Classification of Roads (Length in Kms.)		
	i. Four Lane Roads	648	12
	ii. Double Lane Roads	7419	412
	iii. Intermediate Lane Roads	527	22
	iv. Single Lane Roads	16357	584
	Total	24950	1030
2	Panchayati Raj Department (Length in Kms.)		
	i. Black Top Roads	23185	549
	ii. WBM Roads	13118	377
	iii. Gravel Roads	16343	533
	iv. Earthen Roads	18235	704
	v. Others (CC Roads)	2899	55
	Total	73781	2216
3	Gram Panchayats having Road Facility		
	a GPs having BT roads	8231	130
	b GPs to be covered with BT roads	455	46
4	Habitations (other than GPs) having Road Facility		
	a Total Habitations	15738	1032
	b Habitations having all weather roads	10204	546
	c Habitations not having all weather roads	5534	486
IX	TRANSPORT		
1	Road Transport		
	a RTC Bus Depots	95	1
	b RTC Fleet of Buses	10482	80
	c Daily Operated Length (Kms.)	3631505	31680
2	Railways		
	a Railway Stations	229	3
	b Track Length (Kms.)	1592	35
X	FOREST		
1	Forest Cover (Sq. Kms.)	26904	2420.17
	Percentage of Forest Cover	24.00	49.61
2	Telangana ku Haritha Haram		
	Action Plan for 2017		
	a Nurseries	2843	36
	b Seedlings (lakh Nos.)	4536	121
	c Plantation (lakh Nos.)	4000	110

Sl. No	Parameters	State	Komaram Bheem
XI	IRRIGATION		
1	Irrigation Projects		
a	Major Projects	26	2
b	Medium Projects	34	3
2	Mission Kakatiya		
a	Minor Irrigation Tanks	46531	1005
b	Sanctions accorded for restoration		
	i. Mission Kakatiya Phase-I	8165	200
	ii. Mission Kakatiya Phase-II	9113	140
XII	RURAL WATER SUPPLY		
a	Hand Pumps	157873	5588
b	Protected Water Supply Schemes	21910	508
c	Comprehensive Protected Water Supply Schemes	5364	13
d	Individual Household Latrines	1663839	21957
XIII	MISSION BHAGHEERATHA		
a	Habitations to be Covered	24248	1111
b	Pipeline to be Laid (Kms.)	49286	1901
XIV	INDUSTRIES		
1	i. Industrial Units	28515	55
	ii. Employees	605443	592
	iii. Investment (Rs. Crore)	116022	56
2	TS-iPASS		
	i. Proposed Industries	2926	31
	ii. Proposed Employment	195016	259
	iii. Proposed Investment (Rs. Crore)	49427	31
3	Mines		
a	Mineral Deposits: Lime Stone, Stone Metal, Black Granite		
b	Mines Leased		
	i. Major	104	25
	ii. Minor	2980	12
	Total	3084	37
c	Sand Reaches allotted to TSMDC Ltd.		
	i. Disilting Areas	20	0
	Quantity (CBM)	33911410	0
	ii. Specified Sand bearing Areas	57	0
	Quantity (CBM)	9296724	0
	iii. Pattalands	180	1
	Quantity (CBM)	3840815	15000

Sl. No	Parameters	State	Komaram Bheem
XV	HANDLOOMS AND POWERLOOMS		
a	Societies	336	2
b	Weavers in Cooperative Fold	82438	492
c	Weavers outside Cooperative Fold	38002	0
d	Powerloom Weavers	49112	0
XVI	WELFARE		
1	Scheduled Castes		
a	Colleges attached Hostels	160	3
	Enrollment	19077	106
b	Pre-Matric Hostels	734	7
	Enrollment	59928	547
2	Scheduled Tribes		
a	Student Hostels (incl. Ashram Schools)		
	Hostels for Boys	324	33
	Hostels for Girls	148	13
	Total	472	46
b	Boarders		
	Boys	65635	6006
	Girls	52141	6321
	Total	117776	12327
3	Backward Classes		
a	Student Hostels (incl. Colleges)		
	Hostels for Boys	474	8
	Hostels for Girls	226	3
	Total	700	11
b	Boarders		
	Boys	44373	566
	Girls	24328	151
	Total	68701	717
XVII	RESIDENTIAL SCHOOLS		
a	Scheduled Castes	262	5
	Students	96039	2059
b	Scheduled Tribes	89	5
	Students	21919	1489
c	Backward Classes	23	0
	Students	8282	0
d	Minorities	71	1
	Students	12554	215

Sl. No	Parameters	State	Komaram Bheem
XVIII	WOMEN AND CHILD WELFARE		
a	ICDS Projects	149	5
b	Anganwadi Centres	35700	975
c	Anganwadi Workers	28669	816
d	Anganwadi Helpers	33248	850
e	Children Enrolled	2427396	66300
XIX	RURAL DEVELOPMENT		
a	Self Help Groups	426705	7303
b	SHG Members	4442215	82205
c	SHGs provided with Bank Credit	63049	747
XX	TAX COLLECTION - LOCAL BODIES		
a	Gram Panchayats	8695	173
	Demand (Rs. lakh)	42797	334
b	Urban Local Bodies	73	1
	Demand (Rs. lakh)	164436	138
XXI	POST OFFICES		
a	Head Post Offices	38	0
b	Sub Post Offices	692	10
c	Branch Post Offices	4143	101
	Total	4873	111
XXII	BANK BRANCHES		
a	Nationalized Banks	3413	32
b	Private Banks	833	0
c	Regional Rural Banks	817	0
d	Cooperative Banks	269	6
	Total	5332	38
e	ATMs	4605	17
XXIII	TELEPHONES		
a	Exchanges	1220	11
b	Telephone Connections	507540	1525
c	Public Telephones	6729	0
XXIV	LAW AND ORDER		
	Police Stations	799	19
XXV	TOURISM AND CULTURE		
a	TSTDC Units	49	0
b	Tourist Spots	464	15
c	TSS Artists	550	14



AI

ARTIFICIAL INTELLIGENCE BASED LINE FOLLOWER ROBOT

Organised by Multipurpose Awareness Society ,Hyderabad ,Telangana
sponsor by:NMICPS ,DST,Govt of India

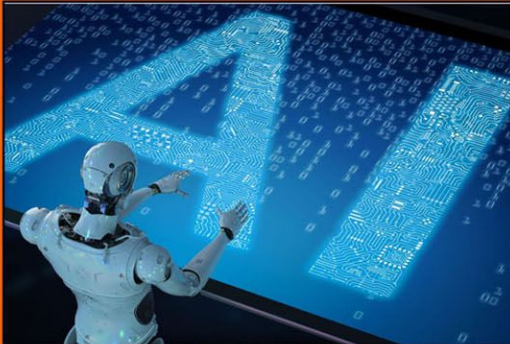

Artificial intelligence (AI)

Artificial intelligence (AI) is the simulation of human **intelligence** processes by machines, especially computer systems. These processes include learning (the acquisition of information and rules for using the information), reasoning (using rules to reach approximate or definite conclusions) and self-correction.

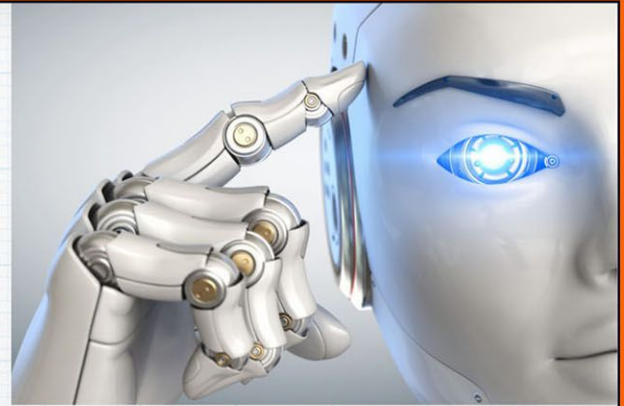

Robotics and artificial intelligence

Robotics and Artificial Intelligence. **Artificial Intelligence (AI)** is a general term that implies the use of a computer to model and/or replicate **intelligent** behavior. Research in **AI** focuses on the development and analysis of algorithms that learn and/or perform **intelligent** behavior with minimal human intervention.



Artificial Intelligence (AI)

AI encompasses developing intelligent learning algorithms. It is about how computer systems can simulate intelligent processes such as learning, reasoning and understanding symbolic information in context.

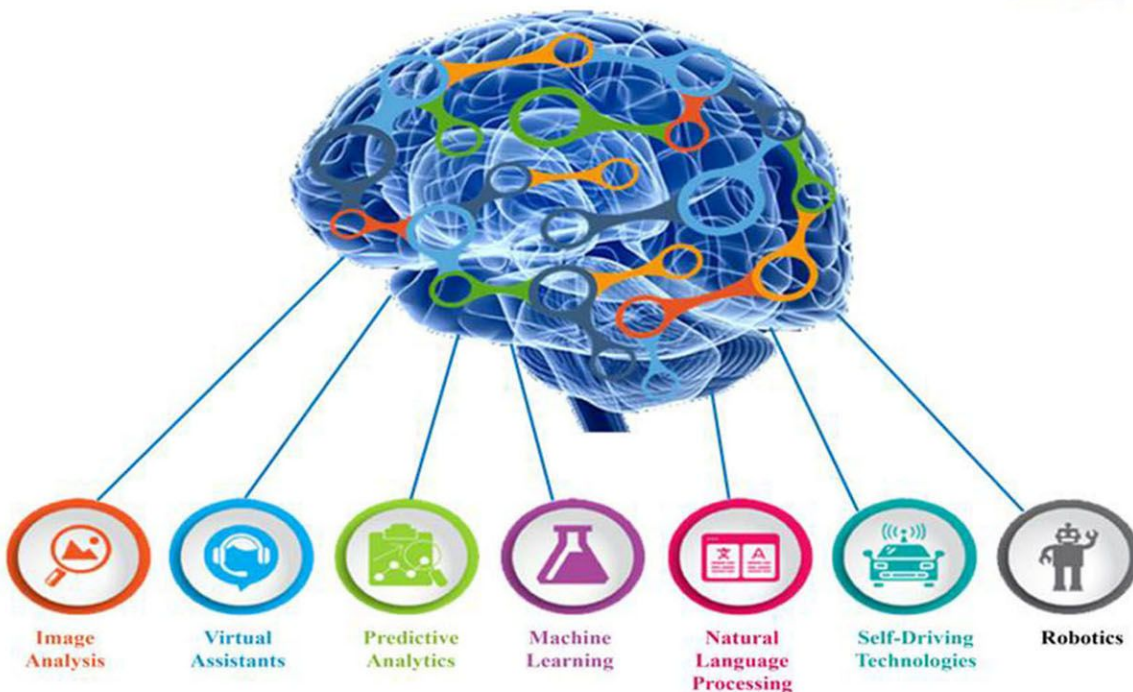



INTRODUCTION

- The line follower is a self operating robot that detects and follows a line that is drawn on the floor. The path consists of a black line on a white surface .
- A Robot is any machine which is completely automatic, i.e. it starts on its own, decides its own way of work and stops on its own. It is actually a replica of human being, which has been designed to ease human burden. It can be controlled pneumatically or using hydraulic ways or using the simple electronic control ways. The first industrial robot was Unimates built by George Devol and Joe Engelberger in the late 50's and early 60's.



WORKING

The IR sensor detects the light emitted by the transmitter, if the receiver receives light, the wheel of that side will keep on moving, as soon as the receiver stops receiving the light (black colour absorbs the light and thus no light is reflected so receiver cannot receive any light) the wheel of that side will stop.

❖For turning ,the robot stops 1 motor and runs the second to make the turn possible.

If the robot has to turn right then the motor on right side will stop and left motor will keep on running and thus allowing the robot to turn.

Components List:

- | | |
|------------------|----------------------------|
| 1. IR sensor | 9. 9volts |
| 2. Robot chassis | 10. Caster wheels |
| 3. BO Motor | 11. Small Zero PCB |
| 4. Wheels | 12. Lead and Soldering Rod |
| 5. Motor Driver | 13. Glue Gun |
| 6. Arduino uno | 14. Jumper Cables |
| 7. DC Jack(Male) | 15. Black sheet |
| 8. Battery Cap | 16. White Tape. |



Robotics

The definition of a Robot is a machine, especially one, that is programmable by a computer and capable of carrying out a complex series of actions.

In Automotive sector

Using for avoiding the exposure of humans to harmful chemicals and toxicity.



Humanoids

Robots which look like humans and are called humanoids. They can be used both at home and in industries.



(Sophia the robot gets a Saudi Arabian Citizenship)



APPLICATION

- ❖ Industrial automated equipment carriers.
- ❖ Automated cars.
- ❖ Tour guides in museums and other similar applications.
- ❖ Deliver the mail within the office building
- ❖ Deliver medications in a hospital.



ADVANTAGES

Robot movement is automatic.

- ❖ Used for long distance applications.
- ❖ It is capable of taking various degrees of turns.
- ❖ Cost effective
- ❖ The color of the line must not be a factor as long as it is darker than the surroundings.



DISADVANTAGE

- ❖ LFR can move on a fixed track or path only.
- ❖ It requires power supply.
- ❖ Lack of speed control makes the robot unstable at times.
- ❖ Choice of line is made in the hardware abstraction and cannot be changed by software

Circuit

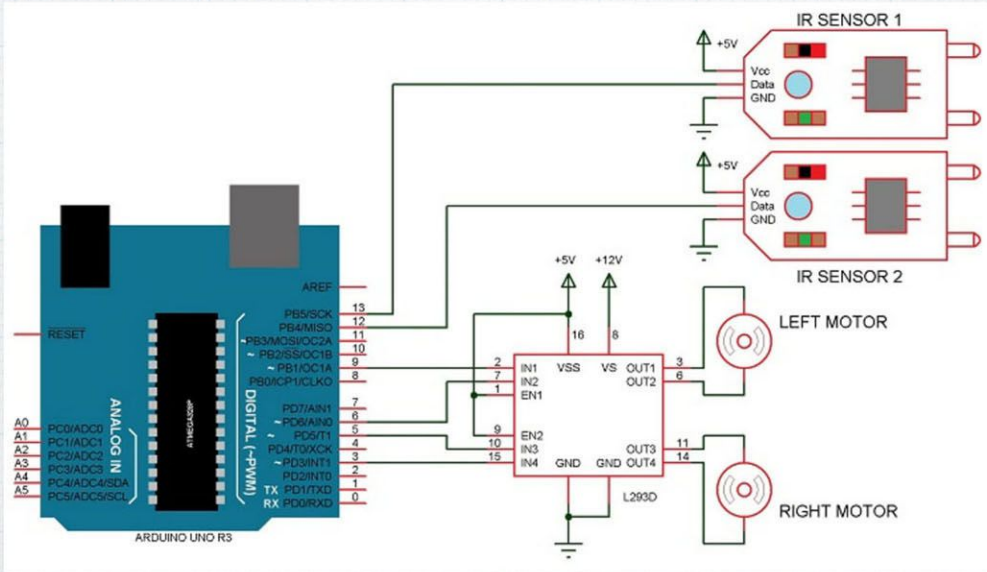

Line Following Algorithm

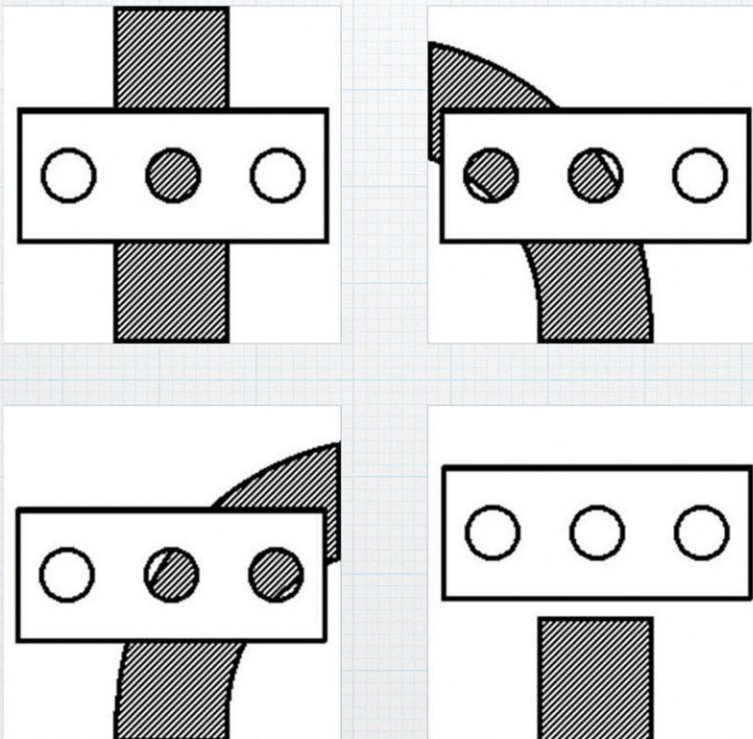



Block Diagram of the Project

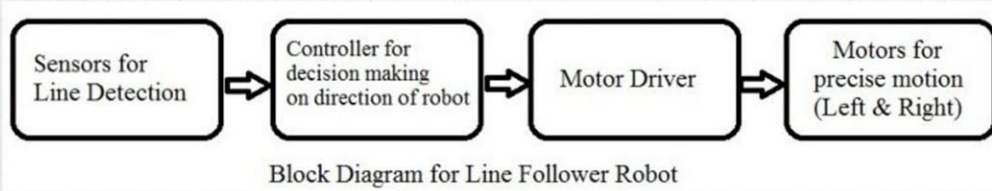

Line Following Algorithm

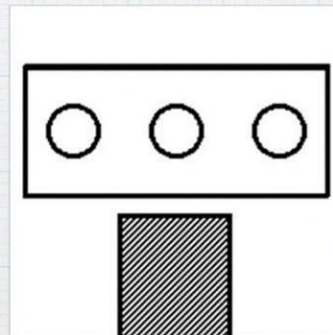
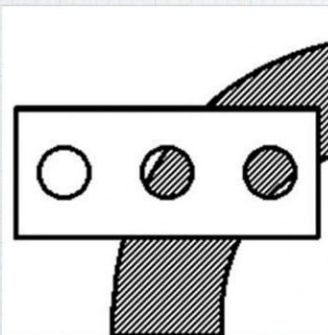
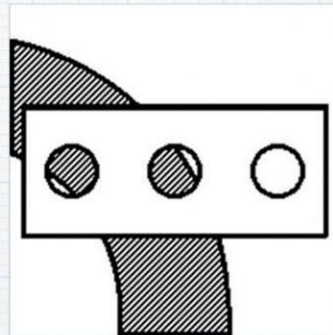
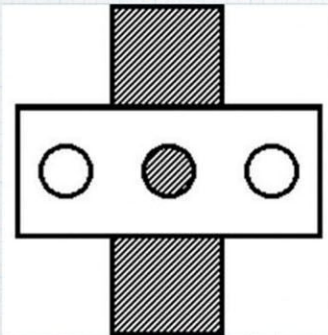

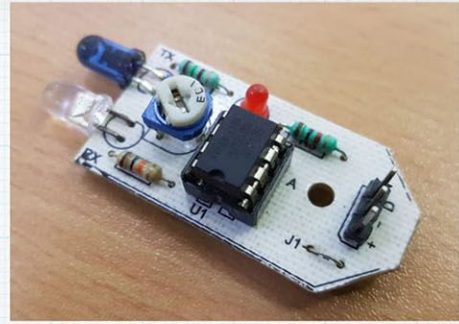

Sensors (IR Sensor):

Sensors (IR Sensor): We have used IR Sensor Module as the line detecting sensor for the project. It consists of an IR LED and a Photo diode and some other components like comparator, LED etc.



FUTURE SCOPE

- ❖ Software control of the line type (dark or light) to make automatic detection possible.
- ❖ “Obstacle detecting sensors” to avoid physical obstacles and continue on the line.
- ❖ Distance sensing and position logging & transmission.



Photodiode



Photodiode



Light Coloured Surface



Black Surface

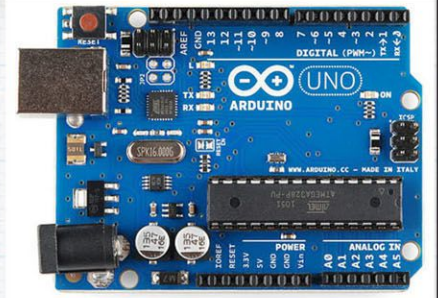

Arduino

Arduino is an open-source hardware and software company, project and user community that designs and manufactures single-board microcontrollers and microcontroller kits for building digital devices.

Interdisciplinary Cyber-Physical Systems (ICPS)

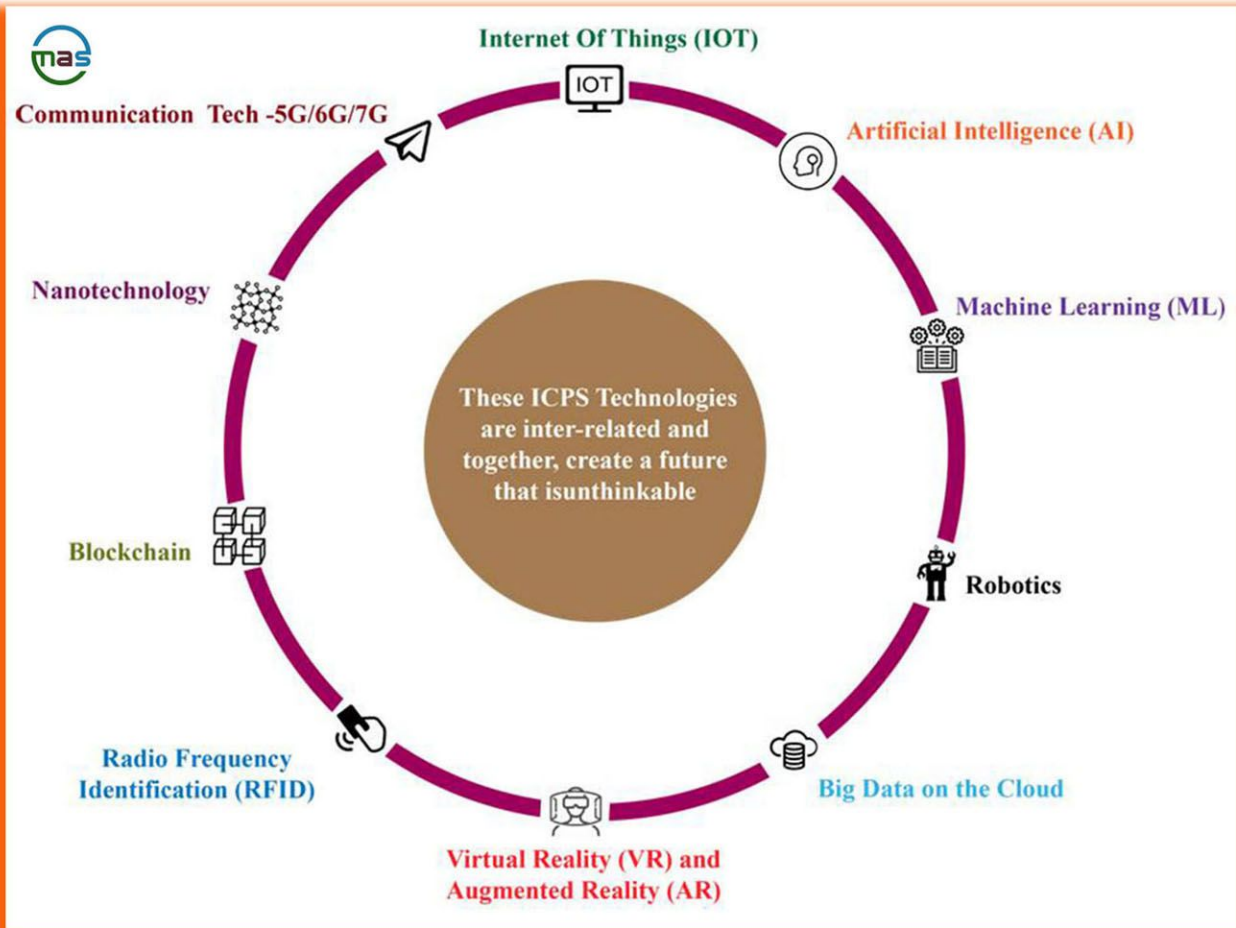

Nanotechnology

- Nanotechnology refers to manipulation of matter on an atomic, molecular and supramolecular scale, with the criterion being manipulation of matter with at least one dimension sized from 1 to 100 nanometers.

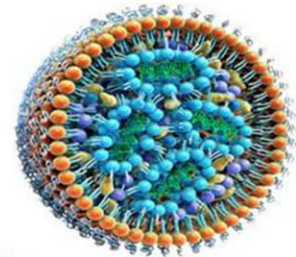

NanoTechnology in Fields Of Science

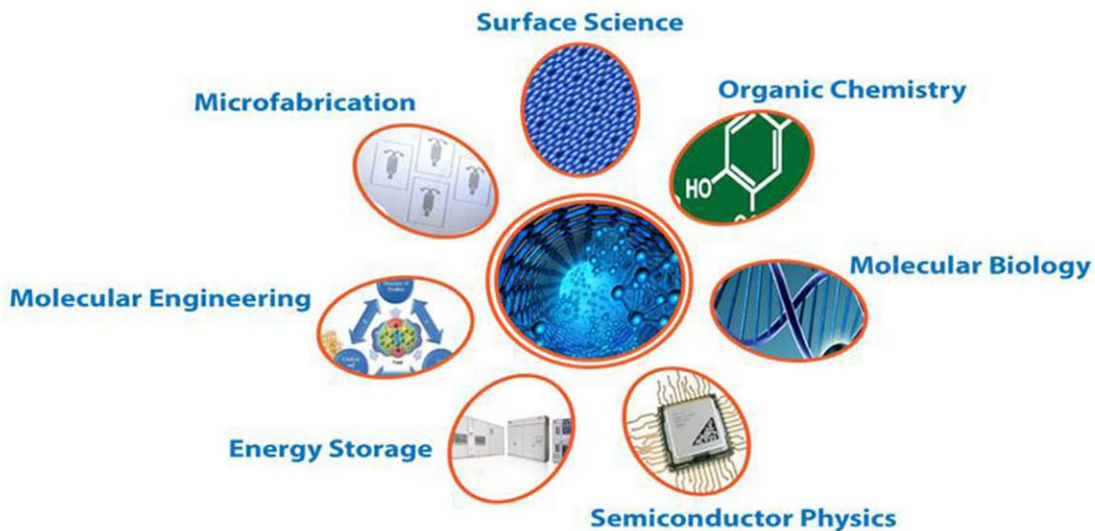

Interdisciplinary Cyber-Physical Systems (ICPS)



Communication Tech 5G/6G/7G

5G or the 5th Generation Telecom Network comprises three important features

- Greater speed
- Lower latency
- Ability to connect a lot more devices at once



6G or 6th Generation Network

- Cheap and Fast
- High data rates
- Fast Internet speed to access on air
- Data ranges up-to 11 Gbps



5G/6G/7G



7G or 7th Generation Network

- Space-roaming
- Ubiquitous Internet
- Rich multimedia data access
- Up-to-the-minute weather updates



Internet of Things (IoT)

➤ IoT is a system of interrelated computing devices, mechanical and digital machines, objects, animals or people that are provided with Unique Identifiers (UIDs) and the ability to transfer data over a network without requiring human-to-human or human-to-computer interaction.



EXAMPLES OF IOT DEVICES IN SMART HOME

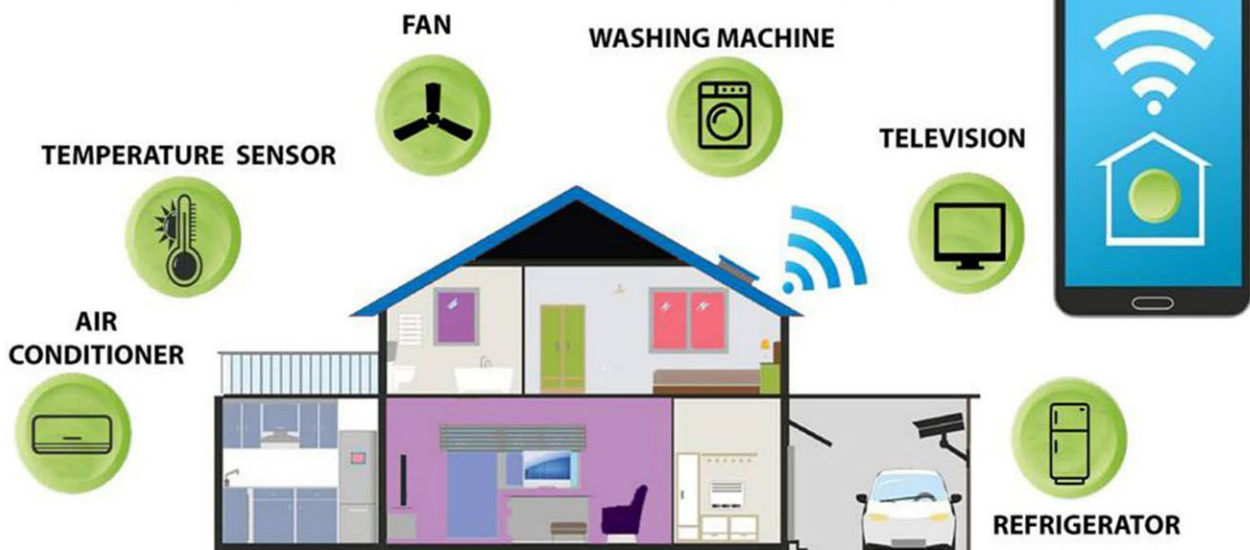

Interdisciplinary Cyber-Physical Systems (ICPS)



Machine Learning

Machine Learning (ML)

Machine Learning or ML is an application of artificial intelligence (AI) that provides systems the ability to automatically learn and improve from experience without being explicitly programmed.

- It focuses on the development of computer programs that can access data and use it learn for themselves.
- The process of learning begins with observations or data, such as examples, direct experience, or instruction, in order to look for patterns in data and make better decisions in the future based on the examples that we provide.
- The primary aim is to allow the computers learn automatically without human intervention or assistance and adjust actions accordingly.



Cloud Server



Big Data

Big Data on the Cloud

Big Data refers to extremely large data sets that may be analyzed computationally to reveal patterns, trends and associations, especially relating to human behavior and interactions.

- Both humans, via, social networks and other channels and machines, through IoT or Internet of Things contribute to Big Data
- The cloud is a term referring to accessing computer, information technology (IT), and software applications through a network connection, often by accessing data centers using wide area networking (WAN) or Internet Connectivity
- Both Big Data and Cloud are a result of the fast growth of the Internet.

Big Data



Analytics



Cloud Platform



Gateway



Simulated Objects

Interdisciplinary Cyber-Physical Systems (ICPS)



Virtual Reality (VR) and Augmented Reality (AR)

Virtual Reality and Augmented Reality are new exciting areas in which the real and virtual worlds are brought together.



➤ Using this technology, one can see, hear, smell and feel sensations as though one were in a real life situation, but actually the experience is via a computer simulation.



➤ With the help of special headsets, glasses and joysticks, one can get a 3D look and feel and enjoy an immersive experience.

➤ Flight Simulator that helps aspiring pilots with how to navigate a plane in real time and with simulations that help them learn how to handle an aircraft during times such as turbulence, engine failure or other emergencies.



Radio Frequency Identification (RFID)

RFID or Radio Frequency Identification helps establish the ID or identity of any object by the use of radio waves.

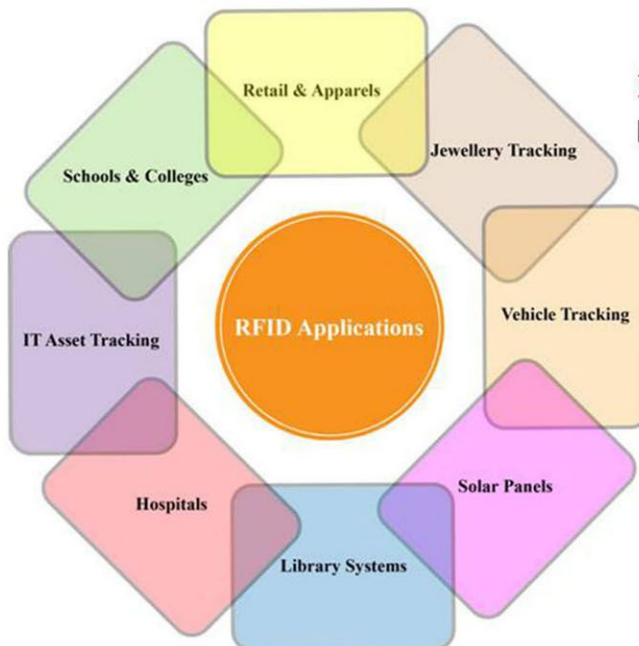

➤ RFID is better than other forms of scanning products

RFID or Radio Frequency Identification:

➤ Helps establish the ID or identity of any object by the use of radio waves

➤ Is used in supply chain, manufacturing, animal tagging, sports etc

➤ Is widely used in tracking goods, people and animals

Interdisciplinary Cyber-Physical Systems (ICPS)



Blockchain

Blockchain is a technology that Protects user data with a high degree of privacy and security

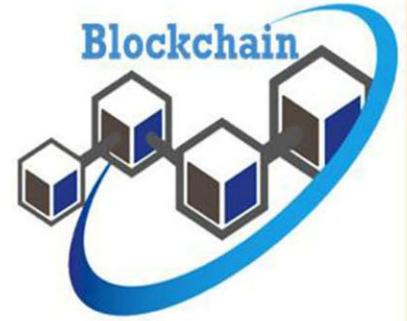

➤ Is also an immutable record where a consensus algorithm works to ensure that valid changes to the data are made only by verified nodes on the network

➤ Can fundamentally alter many industries such as land records, supply chain, finance, medical field, education and more

➤ Also can use Crypto currency that can change the way money or value is transferred from person to person or business to business

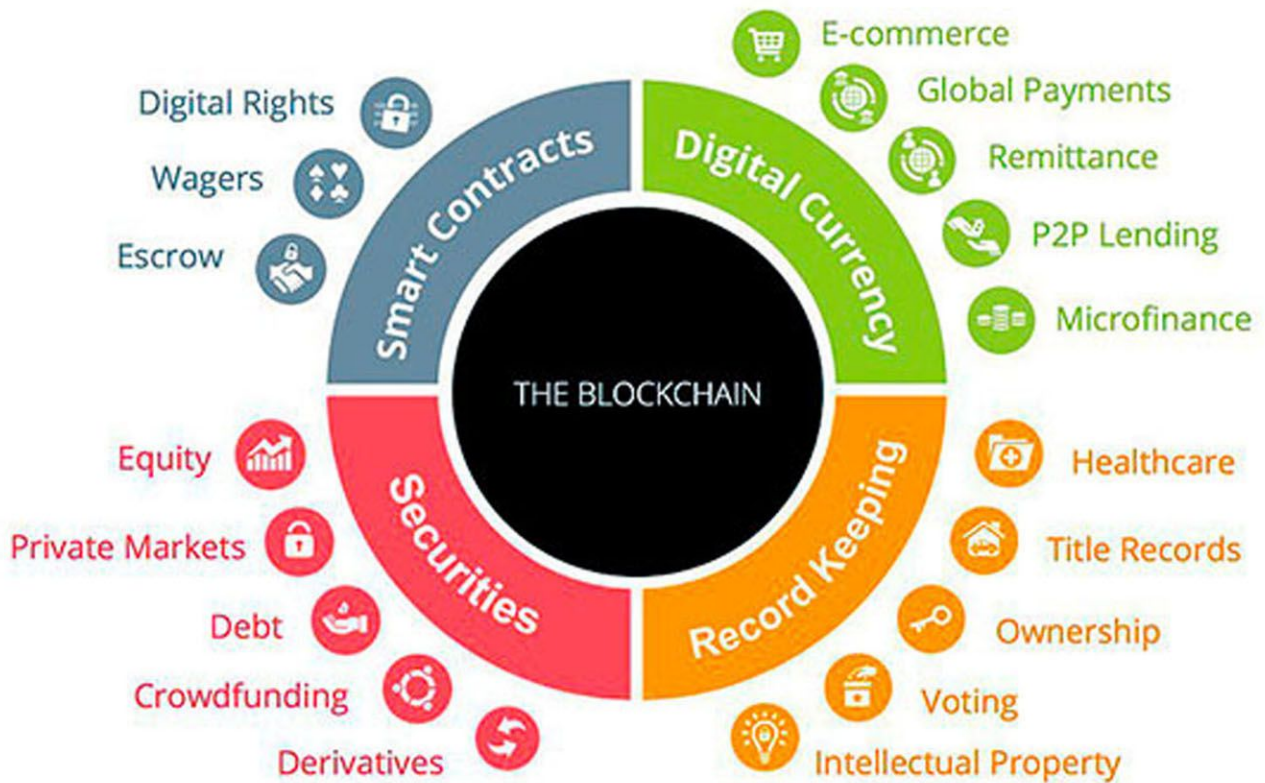
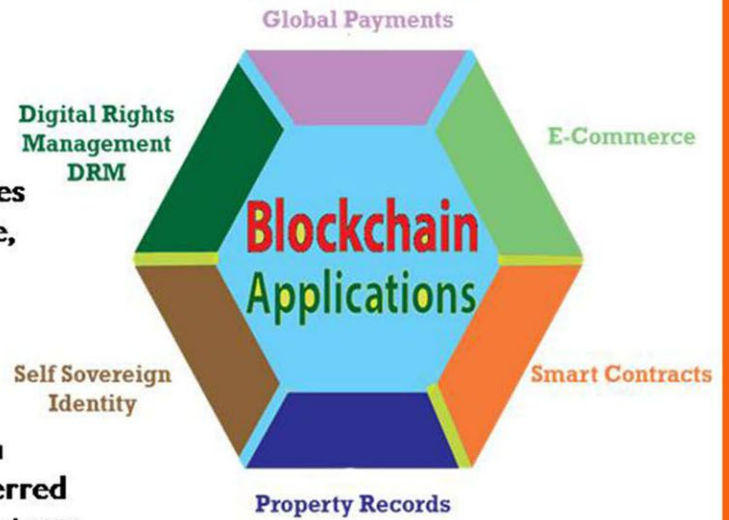



ARTIFICIAL INTELLIGENCE BASED LINE FOLLOWER ROBOT FOR RURAL SCHOOL STUDENTS IN KOMARAM BHEEM ASIFABAD DISTRICT, TELANGANA STATE

PROJECT DEMONSTRATION AND SCHOOL EXPERIMENT ACTIVITIES PHOTOS

Programme Number :01

1. Name of the Program: AI Based Line Following Robotic
2. Date :06.06.2019
3. Place: Govt Jr College, Koutala Mandal Kumaram Bheem Asifabad Dist
4. Demonstration by Boda.Nageswara Rao,PI
5. Press Clippings and Photos:
- 6.Target :Teachers and Students

Press clipping: Namaste Telangana Telugu Daily dt.07.06.2019 Asifabad Dist.

Programme Number :02

1. Name of the Program: AI Based Line Following Robotic
2. Date :19.06.2019
3. Place:Z.P.S.S., Koutala Mandal Kumaram Bheem Asifabad Dist
4. Demonstration by Boda.Nageswara Rao,PI
5. Photos:
- 6.Target: Teachers & Students

Certificates

SCHOOL AWARENESS PROGRAMS REGISTRATION FOAM P-3

S.No.	Description	Details
1	Organization Name:	Multipurpose Awareness Society
2	Project Name:	Artificial intelligence line following Robot
3	Sponsored by:	NM-1CPS DIVISION, DST, GOI
4	School Name:	K.G.B.V KOUTALA
5	Address School :	K.G.B.V Koutala, Village: Koutala, Kumarambheem Dist 504299
6	Signature of School principal with stamp	<i>[Signature]</i> SPECIAL OFFICER K.G.B.V. KOUTALA Mdl: Koutala Dist. Kumaram Bheem Ast.
7	Mobile Number :	8499075059
8	Date of Program:	06-07-2019
9	Model is Registered in School Science Book	SPECIAL OFFICER K.G.B.V. KOUTALA Mdl: Koutala Dist. Kumaram Bheem Ast.
10	Feed back of the School Science Teacher /Students	(90%)
11	Signature of Project Trainer	<i>[Signature]</i>
12	Signature of Project Investigator	<i>[Signature]</i>

SCHOOL AWARENESS PROGRAMS REGISTRATION FOAM P-4

S.No.	Description	Details
1	Organization Name:	Multipurpose Awareness Society
2	Project Name:	Artificial intelligence line following Robot
3	Sponsored by:	NM-1CPS DIVISION, DST, GOI
4	School Name:	Infant Jesus G/j School.
5	Address School :	Koutala dist: Kumarambheem, asifabad
6	Signature of School principal with stamp	<i>[Signature]</i> HEADMASTER INFANT JESUS G/J SCHOOL A Unit of District of Kumaram Bheem Educational Society Vill & Mdl: KOUTALA-504299 Dist. Kumarambheem Asifabad TS
7	Mobile Number :	
8	Date of Program:	06-07-2019
9	Model is Registered in School Science Book	HEADMASTER INFANT JESUS G/J SCHOOL A Unit of District of Kumaram Bheem Educational Society Vill & Mdl: KOUTALA-504299 Dist. Kumarambheem Asifabad TS
10	Feed back of the School Science Teacher /Students	
11	Signature of Project Trainer	<i>[Signature]</i>
12	Signature of Project Investigator	<i>[Signature]</i>



**ARTIFICIAL INTELLIGENCE BASED LINE FOLLOWER ROBOT
FOR RURAL SCHOOL STUDENTS IN KOMARAM BHEEM ASIFABAD
DISTRICT, TELANGANA STATE**
PROJECT DEMONSTRATION AND SCHOOL EXPERIMENT ACTIVITIES
Certificates

SCHOOL AWARENESS PROGRAMS REGISTRATION FOAM P-5

S.No.	Description	Details
1	Organization Name:	Multipurpose Awareness Society
2	Project Name:	Artificial intelligence line following robot
3	Sponsored by:	NM-ICPS Division, DST, GOI
4	School Name:	Govt. Ashram High School
5	Address School:	Mogad Abad mandal - Koutala dist. - K. Bheem asifabad
6	Signature of School principal with stamp	
7	Mobile Number:	-
8	Date of Program:	04-07-2019
9	Model is Registered in School Science Book	
10	Feed back of the School Science Teacher /Students	OK
11	Signature of Project Trainer	K. Prasad
12	Signature of Project Investigator	B. N. S. R.

SCHOOL AWARENESS PROGRAMS REGISTRATION FOAM P-6

S.No.	Description	Details
1	Organization Name:	Multipurpose Awareness Society
2	Project Name:	Artificial intelligence line following robot
3	Sponsored by:	NM-ICPS DIVISION DST, GOI
4	School Name:	Z.P.S.S. Muthampet - Md: Koutala -
5	Address School:	Muthampet mandal - Koutala dist. - K. Bheem asifabad.
6	Signature of School principal with stamp	
7	Mobile Number:	9441069511
8	Date of Program:	05-07-2019
9	Model is Registered in School Science Book	
10	Feed back of the School Science Teacher /Students	good
11	Signature of Project Trainer	K. Prasad
12	Signature of Project Investigator	B. N. S. R.

SCHOOL AWARENESS PROGRAMS REGISTRATION FOAM P-7

S.No.	Description	Details
1	Organization Name:	Multipurpose Awareness Society
2	Project Name:	Artificial intelligence line following Robot.
3	Sponsored by:	NM-ICPS Division DST GOI
4	School Name:	Eden Garden High School
5	Address School:	Sirpur - T. dist. - Kumram Bheem Asifabad
6	Signature of School principal with stamp	
7	Mobile Number:	-
8	Date of Program:	05-07-2019
9	Model is Registered in School Science Book	
10	Feed back of the School Science Teacher /Students	good
11	Signature of Project Trainer	K. Prasad
12	Signature of Project Investigator	B. N. S. R.

SCHOOL AWARENESS PROGRAMS REGISTRATION FOAM P-8

S.No.	Description	Details
1	Organization Name:	Multipurpose Awareness Society
2	Project Name:	Artificial intelligence line following Robot.
3	Sponsored by:	NM-ICPS DIVISION DST, GOI
4	School Name:	Z.P.H.S. Sirpur (T) asifabad.
5	Address School:	mandal - Sirpur (T). dist. - Kumram Bheem asifabad.
6	Signature of School principal with stamp	
7	Mobile Number:	6301875218
8	Date of Program:	05-07-2019
9	Model is Registered in School Science Book	
10	Feed back of the School Science Teacher /Students	OK
11	Signature of Project Trainer	K. Prasad
12	Signature of Project Investigator:	B. N. S. R.



**ARTIFICIAL INTELLIGENCE BASED LINE FOLLOWER ROBOT
FOR RURAL SCHOOL STUDENTS IN KOMARAM BHEEM ASIFABAD
DISTRICT, TELANGANA STATE**
PROJECT DEMONSTRATION AND SCHOOL EXPERIMENT ACTIVITIES

Certificates

SCHOOL AWARENESS PROGRAMS REGISTRATION FOAM P-9

S.No.	Description	Details
1	Organization Name:	Multipurpose Awareness Society
2	Project Name:	Artificial Intelligence line following robot.
3	Sponsored by:	NM-ICPS DIVISION, DST GOI
4	School Name:	ZPSS, bodampally.
5	Address School:	Bodampally mandal - Koutala dist. - Kumram bheem asifabad.
6	Signature of School principal with stamp	 HEAD MASTER ZPSS: BODAMPALLY. Mandal: Koutala, Dist. KumramBheem Asifabad.
7	Mobile Number:	-
8	Date of Program:	06-07-2019
9	Model is Registered in School Science Book	 HEAD MASTER ZPSS: BODAMPALLY. Mandal: Koutala, Dist. KumramBheem Asifabad.
10	Feed back of the School Science Teacher /Students	✓
11	Signature of Project Trainer	Kharyal
12	Signature of Project Investigator	BMY

SCHOOL AWARENESS PROGRAMS REGISTRATION FOAM P-10

S.No.	Description	Details
1	Organization Name:	Multipurpose Awareness Society
2	Project Name:	Artificial intelligence line following Robot.
3	Sponsored by:	NM-ICPS DIVISION DST, GOI
4	School Name:	Z.P.S.S. DABBA
5	Address School:	Mdl:-CHINTHALAMANEPALLY Dist: K.B. Asifabad.
6	Signature of School principal with stamp	 HEAD MASTER ZPSS DABBA Mdl. Chinthalamaneppally Dist. KumramBheem-Asifabad.
7	Mobile Number:	9885737190
8	Date of Program:	06-07-2019
9	Model is Registered in School Science Book	HEAD MASTER ZPSS DABBA Mdl. Chinthalamaneppally Dist. KumramBheem-Asifabad.
10	Feed back of the School Science Teacher /Students	✓
11	Signature of Project Trainer	Kharyal
12	Signature of Project Investigator	BMY

School Mail ID
ZPSS dabba 2016 @ gmail. com

SCHOOL AWARENESS PROGRAMS REGISTRATION FOAM P-11

S.No.	Description	Details
1	Organization Name:	Multipurpose Awareness Society
2	Project Name:	Artificial Intelligence line following Robot.
3	Sponsored by:	NM-ICPS DIVISION DST, GOI
4	School Name:	T.S LPS (boys)
5	Address School:	mandal - Sirpur.T dist. - Kumram bheem asifabad.
6	Signature of School principal with stamp	 PRINCIPAL TSWAS & JC (BOYS) SIRPUR-T-504299 Dist. KumramBheem Asif.
7	Mobile Number:	8008003626
8	Date of Program:	07-07-2019
9	Model is Registered in School Science Book	 PRINCIPAL TSWAS & JC (BOYS) SIRPUR-T-504299 Dist. KumramBheem Asif.
10	Feed back of the School Science Teacher /Students	✓
11	Signature of Project Trainer	Kharyal
12	Signature of Project Investigator	BMY

durgamthulavaram 660 @ gmail. com

SCHOOL AWARENESS PROGRAMS REGISTRATION FOAM P-12

S.No.	Description	Details
1	Organization Name:	Multipurpose Awareness Society
2	Project Name:	Artificial intelligence line following Robot
3	Sponsored by:	NM-ICPS DIVISION DST, GOI
4	School Name:	T.S LPS (girls)
5	Address School:	Sirpur (T), dist - Kumram bheem asifabad.
6	Signature of School principal with stamp	 PRINCIPAL T.S.W.R. College (G) Sirpur (T) Dist. Kumram Bheem Asifabad.
7	Mobile Number:	6302216014
8	Date of Program:	07-07-2019
9	Model is Registered in School Science Book	 PRINCIPAL T.S.W.R. College (G) Sirpur (T) Dist. Kumram Bheem Asifabad.
10	Feed back of the School Science Teacher /Students	✓
11	Signature of Project Trainer	Kharyal
12	Signature of Project Investigator	BMY



ARTIFICIAL INTELLIGENCE BASED LINE FOLLOWER ROBOT FOR RURAL SCHOOL STUDENTS IN KOMARAM BHEEM ASIFABAD DISTRICT, TELANGANA STATE
PROJECT DEMONSTRATION AND SCHOOL EXPERIMENT ACTIVITIES

Certificates

P-13

School Awareness Programs registration foam

S.No.	Description	Details
1	Organization Name	Multipurpose Awareness Society
2	Project Name	AI line following Robot
3	Sponsored by	NMICPS DST, GOI
4	School Name	K.G. B.V
5	School Address	Chinthalamaneppally.
6	Signature of School Principal with Stamp	 Special Officer G.B.V.Chinthalamaneppally Dist.Kuram Bheem-Asifabad
7	Mobile Number	6301293073
8	Program Date	Date : 18/07/19 Nos of student : 45
9	Science Model is registered in school science book	Yes/Sign: R.Sing R. Sadaswati
10	Feedback demonstration project	Good /Excellent 8/5. 9/5
11	Signature of Project Trainer	K.Padmal
12	Signature of Project Investigator	Billy

P-14

School Awareness Programs registration foam

S.No.	Description	Details
1	Organization Name	Multipurpose Awareness Society
2	Project Name	AI line following Robot.
3	Sponsored by	NMICPS DST GOI
4	School Name	Govt. Ashram High School
5	School Address	Babapur,
6	Signature of School Principal with Stamp	 HEAD MASTER Govt. AHS (G) Babapur Mdi: Chinthalamaneppally Dist: Kuram Bheem-Asifabad, T.S
7	Mobile Number	9440871967
8	Program Date	Date : 18/07/19 Nos Student : 44
9	Science Model is registered in school science book	Yes/Sign:
10	Feedback demonstration project	Good /Excellent
11	Signature of Project Trainer	K.Padmal
12	Signature of Project Investigator	Billy

P-15

School Awareness Programs registration foam

S.No.	Description	Details
1	Organization Name	Multipurpose Awareness Society
2	Project Name	Artificial intelligence line following Robot.
3	Sponsored by	N.M. ICPS DIVISION, DST Govt of India
4	School Name	Govt. High School
5	School Address	Babapur, gangapur Rangareddy.
6	Signature of School Principal with Stamp	 HEAD MASTER GOVT. HIGH SCHOOL, (G) of Rangareddy Dist: Kuram Bheem-Asifabad
7	Mobile Number	
8	Program Date	Date : 18-July-2019 Nos of Student : 52
9	Science Model is registered in school science book	Yes/Sign:
10	Feedback demonstration project	Good /Excellent
11	Signature of Project Trainer	K.Padmal
12	Signature of Project Investigator	Billy

P-16

School Awareness Programs registration foam

S.No.	Description	Details
1	Organization Name	Multipurpose Awareness Society
2	Project Name	Artificial intelligence line following Robot
3	Sponsored by	NMICPS DST, GOI
4	School Name	ZPSS
5	School Address	Gangapur
6	Signature of School Principal with Stamp	 HEAD MASTER ZPSS GANGAPUR Mdi: Chinthalamaneppally Kuram Bheem-Asif Dist
7	Mobile Number	9440643526
8	Program Date	Date : 18/07/19 Number of Student : 37
9	Science Model is registered in school science book	Yes/Sign:
10	Feedback demonstration project	Good /Excellent
11	Signature of Project Trainer	K.Padmal
12	Signature of Project Investigator	Billy



**ARTIFICIAL INTELLIGENCE BASED LINE FOLLOWER ROBOT
FOR RURAL SCHOOL STUDENTS IN KOMARAM BHEEM ASIFABAD
DISTRICT, TELANGANA STATE
PROJECT DEMONSTRATION AND SCHOOL EXPERIMENT ACTIVITIES**

Certificates

School Awareness Programs registration foam P-17

S.No.	Description	Details
1	Organization Name	Multipurpose Awareness Society
2	Project Name	AI Line following Robot
3	Sponsored by	NMICPS DST, GOI
4	School Name	UPS
5	School Address	Rudin pur
6	Signature of School Principal with Stamp	
7	Mobile Number	8466947629
8	Program Date	Date: 19/07/2019 No. student: 20
9	Science Model is registered in school science book	Yes/ Sign:
10	Feedback demonstration project	Good /Excellent
11	Signature of Project Trainer	
12	Signature of Project Investigator	

School Awareness Programs registration foam P-18

S.No.	Description	Details
1	Organization Name	Multipurpose Awareness Society
2	Project Name	AI line following Robot
3	Sponsored by	NMICPS DST, GOI
4	School Name	Z.P.S.S.
5	School Address	Baba Sagar
6	Signature of School Principal with Stamp	
7	Mobile Number	9441473120
8	Program Date	Date: 19/07/19 No student: 70
9	Science Model is registered in school science book	Yes/ Sign:
10	Feedback demonstration project	Good /Excellent
11	Signature of Project Trainer	
12	Signature of Project Investigator	

School Awareness Programs registration foam P-19

S.No.	Description	Details
1	Organization Name	Multipurpose Awareness Society
2	Project Name	Artificial intelligence line following Robot
3	Sponsored by	NMICPS DST GOI
4	School Name	Z.P.S.S.
5	School Address	Chinthalamaneppally
6	Signature of School Principal with Stamp	
7	Mobile Number	9441255550
8	Program Date	Date: 19/07/2019 No. student: 38
9	Science Model is registered in school science book	Yes/ Sign:
10	Feedback demonstration project	Good /Excellent
11	Signature of Project Trainer	
12	Signature of Project Investigator	

School Awareness Programs registration foam P-20

S.No.	Description	Details
1	Organization Name	Multipurpose Awareness Society
2	Project Name	Artificial intelligence line following Robot
3	Sponsored by	NMICPS DST, GOI
4	School Name	Govt. Ashram High School
5	School Address	Salugupally
6	Signature of School Principal with Stamp	
7	Mobile Number	9441519086
8	Program Date	Date: 19/07/2019 No student: 80
9	Science Model is registered in school science book	Yes/ Sign:
10	Feedback demonstration project	Good /Excellent
11	Signature of Project Trainer	
12	Signature of Project Investigator	



**ARTIFICIAL INTELLIGENCE BASED LINE FOLLOWER ROBOT
FOR RURAL SCHOOL STUDENTS IN KOMARAM BHEEM ASIFABAD
DISTRICT, TELANGANA STATE**
PROJECT DEMONSTRATION AND SCHOOL EXPERIMENT ACTIVITIES

Certificates

School Awareness Programs registration foam p-21

S.No.	Description	Details
1	Organization Name	Multipurpose Awareness Society
2	Project Name	AI line following Robot
3	Sponsored by	NMICPS DST, GOI
4	School Name	ZPSS, Bejjur
5	School Address	Bejjur
6	Signature of School Principal with Stamp	 Head Master (FAC) ZPSS BEJJUR, Dist: KB Asifabad (TS)
7	Mobile Number	9494026265
8	Program Date	Date: 20.07.2019 Nos Student: 85
9	Science Model is registered in school science book	Yes/ Sign:
10	Feedback demonstration project	Good /Excellent
11	Signature of Project Trainer	Kalpavathi
12	Signature of Project Investigator	Billy

School Awareness Programs registration foam p-22

S.No.	Description	Details
1	Organization Name	Multipurpose Awareness Society
2	Project Name	Artificial intelligence line following Robot
3	Sponsored by	NMICPS DST, GOI
4	School Name	M.P.U.P.S
5	School Address	Bareguda
6	Signature of School Principal with Stamp	 HEADMASTER M.P.U.P.S BAREGUDA, Dist: Bejjur, Dist: KB Asifabad
7	Mobile Number	995747789
8	Program Date	Date: 22 Nos Student: 20/02/2019
9	Science Model is registered in school science book	Yes/ Sign:
10	Feedback demonstration project	Good /Excellent
11	Signature of Project Trainer	Kalpavathi
12	Signature of Project Investigator	Billy

School Awareness Programs registration foam p-23

S.No.	Description	Details
1	Organization Name	Multipurpose Awareness Society
2	Project Name	Artificial intelligence line following Robot
3	Sponsored by	NMICPS DST, GOI
4	School Name	Z.P.S.S.
5	School Address	Sahyapally.
6	Signature of School Principal with Stamp	 HEAD MASTER Z.P.S.S. SAHYAPALLY, Dist: Bejjur
7	Mobile Number	9959359881
8	Program Date	Date: 20/02/2019 Nos Student: 75
9	Science Model is registered in school science book	Yes/ Sign:
10	Feedback demonstration project	Good /Excellent
11	Signature of Project Trainer	Kalpavathi
12	Signature of Project Investigator	Billy

School Awareness Programs registration foam p-24

S.No.	Description	Details
1	Organization Name	Multipurpose Awareness Society
2	Project Name	AI line following Robot
3	Sponsored by	NMICPS DST, GOI
4	School Name	K.G.B.V
5	School Address	Bejjur
6	Signature of School Principal with Stamp	 Special Officer K.G.B.V School Bejjur-4, Dist: KB Asifabad
7	Mobile Number	9052572727
8	Program Date	22/02/2019
9	Science Model is registered in school science book	Yes/ Sign:
10	Feedback demonstration project	Good /Excellent
11	Signature of Project Trainer	Kalpavathi
12	Signature of Project Investigator	Billy

amkya.gracy@gmail.com



**ARTIFICIAL INTELLIGENCE BASED LINE FOLLOWER ROBOT
FOR RURAL SCHOOL STUDENTS IN KOMARAM BHEEM ASIFABAD
DISTRICT, TELANGANA STATE**
PROJECT DEMONSTRATION AND SCHOOL EXPERIMENT ACTIVITIES

Certificates

School Awareness Programs registration foam p-15

S.No.	Description	Details
1	Organization Name	Multipurpose Awareness Society
2	Project Name	AI line following Robot
3	Sponsored by	NMDCPS DST, GOI
4	School Name	Govt. Ashram high school (girls)
5	School Address	Bejjur
6	Signature of School Principal with Stamp	 HEAD MASTER Govt. Ashram High School (G, BEJJUR Dist: Kumaram Bheem Asifabad
7	Mobile Number	8179261238
8	Program Date	Date : 22/02/2019 nos student : 42
9	Science Model is registered in school science book	Yes/Sign:
10	Feedback demonstration project	Good /Excellent
11	Signature of Project Trainer	Krupa-raj
12	Signature of Project Investigator	Billy

School Awareness Programs registration foam p-16

S.No.	Description	Details
1	Organization Name	Multipurpose Awareness Society
2	Project Name	AI line following Robot
3	Sponsored by	NMDCPS DST, GOI
4	School Name	Govt. Ashram High School (Boys)
5	School Address	Kothan?
6	Signature of School Principal with Stamp	 Head Master Govt. AHS Kethini (Boys) Mol. Chinthamani nagally Kumram Bheem (Asif Dist)
7	Mobile Number	9441844106
8	Program Date	Date : 22/02/2019 nos student : 38
9	Science Model is registered in school science book	Yes/Sign:
10	Feedback demonstration project	Good /Excellent
11	Signature of Project Trainer	Krupa-raj
12	Signature of Project Investigator	Billy

School Awareness Programs registration foam p-17

S.No.	Description	Details
1	Organization Name	Multipurpose Awareness Society
2	Project Name	AI line following Robot
3	Sponsored by	ICPS, DST, GOVT OF INDIA
4	School Name	Govt. ashram high school
5	School Address	Somni?
6	Signature of School Principal with Stamp	 HEAD MASTER Govt. A.H.S Somni Govt. Bejjur 504 299 Dist: Kumaram Bheem Asif
7	Mobile Number	
8	Program Date	Date : 16/2/19 Number & Student : 23/02/2019
9	Science Model is registered in school science book	Yes/Sign:
10	Feedback demonstration project	Good /Excellent
11	Signature of Project Trainer	Krupa-raj
12	Signature of Project Investigator	Billy

torremmadhuni@e-mail.com

SCHOOL AWARENESS PROGRAMS REGISTRATION FOAM p-18

S.No.	Description	Details
1	Organization Name:	MULTIPURPOSE AWARENESS SOCIETY
2	Project Name:	ARTIFICIAL INTELLIGENCE BASED LINE FOLLOWING ROBOTS
3	Theme :	DEMONSTRATION ON MODEL OF LATEST TECHNOLOGY RELEVANT ROBOT AND AI
4	Sponsored by:	DEPARTMENT OF SCIENCE & TECHNOLOGY GOVERNMENT OF INDIA
5	School Name:	
6	Address School:	M.P.P.S Dadanagar M.P.P.S Dadanagar Kothani Kuphar Nagar
7	Signature of School principal with stamp	 Headmistress M.P.P.S (Urdu Medium) Dadanagar, Mol. Kaghaznagar Dist: Kumaram Bheem Asifabad
8	Mobile Number:	970993330
9	Date of Program:	25-7-2019
10	Number of Student Participated	28
11	Model is Registered in School Science Book	yes
12	Feed back of the School Science Teacher /Students	Good/Excellent
13	Signature of Project Trainer	B. Prini
14	Signature of Project Investigator	Billy



**ARTIFICIAL INTELLIGENCE BASED LINE FOLLOWER ROBOT
FOR RURAL SCHOOL STUDENTS IN KOMARAM BHEEM ASIFABAD
DISTRICT, TELANGANA STATE**
PROJECT DEMONSTRATION AND SCHOOL EXPERIMENT ACTIVITIES

Certificates

P-29

S.No.	Description	Details
1	Organization Name:	MULTIPURPOSE AWARENESS SOCIETY
2	Project Name:	ARTIFICIAL INTELLIGENCE BASED LINE FOLLOWING ROBOTS WITH (IOT)
3	Theme :	DEMONSTRATION ON MODEL OF LATEST TECHNOLOGY RELEVANT ROBOT AND AI
4	Sponsored by:	DEPARTMENT OF SCIENCE & TECHNOLOGY GOVERNMENT OF INDIA
5	School Name:	M.P.P. School, KOSINI.
6	Address School :	M.P.P. School, KOSINI S.K.Z.R. Dist. Komaram Bheem. Pm: 504296.
7	Signature of School principal with stamp	 HEAD MASTER M.P.P. S. Kosini Mol. Kagalaznagar
8	Mobile Number :	9959420243
9	Date of Program:	25.07.2019.
10	Number of Student Participated	85
11	Model is Registered in School Science Book	Yes
12	Feed back of the School Science Teacher /Students	Good/Excellent
13	Signature of Project Trainer	B. Nani
14	Signature of Project Investigator	Billy

P-30

S.No.	Description	Details
1	Organization Name:	MULTIPURPOSE AWARENESS SOCIETY
2	Project Name:	ARTIFICIAL INTELLIGENCE BASED LINE FOLLOWING ROBOTS WITH (IOT)
3	Theme :	DEMONSTRATION ON MODEL OF LATEST TECHNOLOGY RELEVANT ROBOT AND AI
4	Sponsored by:	DEPARTMENT OF SCIENCE & TECHNOLOGY GOVERNMENT OF INDIA
5	School Name:	Jawahar Nardaya Vidyalaya Siper kagalaznagar
6	Address School :	Jawahar Nardaya Vidyalaya Siper kagalaznagar Komarambheem Asifabad Telangana - 504296
7	Signature of School principal with stamp	 SCHOOL PRINCIPAL Jawahar Nardaya Vidyalaya Siper kagalaznagar Dist. Komaram Bheem Asifabad
8	Mobile Number :	8500238497
9	Date of Program:	26-7-19
10	Number of Student Participated	240
11	Model is Registered in School Science Book	Yes.
12	Feed back of the School Science Teacher /Students	Good/Excellent
13	Signature of Project Trainer	B. Nani
14	Signature of Project Investigator	Billy

P-31

S.No.	Description	Details
1	Organization Name:	MULTIPURPOSE AWARENESS SOCIETY
2	Project Name:	ARTIFICIAL INTELLIGENCE BASED LINE FOLLOWING ROBOTS
3	Theme :	DEMONSTRATION ON MODEL OF LATEST TECHNOLOGY RELEVANT ROBOT AND AI
4	Sponsored by:	DEPARTMENT OF SCIENCE & TECHNOLOGY GOVERNMENT OF INDIA
5	School Name:	Z.P.S.S (Gr) Sirsilk.
6	Address School :	Z.P.S.S (Gr) Sirsilk. Kagalaznagar. Dist. Komarambheem.
7	Signature of School principal with stamp	 SCHOOL PRINCIPAL Z.P.S.S (Gr) Sirsilk. Kagalaznagar. Dist. Komarambheem.
8	Mobile Number :	9948497265
9	Date of Program:	27-7-19
10	Number of Student Participated	62
11	Model is Registered in School Science Book	Yes
12	Feed back of the School Science Teacher /Students	Good/Excellent
13	Signature of Project Trainer	 Z.P.P. (Girls) Secondary School Kagalaznagar
14	Signature of Project Investigator	Billy

P-32

S.No.	Description	Details
1	Organization Name:	MULTIPURPOSE AWARENESS SOCIETY
2	Project Name:	ARTIFICIAL INTELLIGENCE BASED LINE FOLLOWING ROBOTS
3	Theme :	DEMONSTRATION ON MODEL OF LATEST TECHNOLOGY RELEVANT ROBOT AND AI
4	Sponsored by:	DEPARTMENT OF SCIENCE & TECHNOLOGY GOVERNMENT OF INDIA
5	School Name:	K.G.B.V, Kagalaznagar
6	Address School :	P.R.O colony
7	Signature of School principal with stamp	 SPECIAL OFFICER K.G.B.V. Kagalaznagar, Dist. Komaram Bheem Asifabad
8	Mobile Number :	9702201031
9	Date of Program:	27/07/19
10	Number of Student Participated	198
11	Model is Registered in School Science Book	Yes
12	Feed back of the School Science Teacher /Students	Good/Excellent
13	Signature of Project Trainer	
14	Signature of Project Investigator	Billy



**ARTIFICIAL INTELLIGENCE BASED LINE FOLLOWER ROBOT
FOR RURAL SCHOOL STUDENTS IN KOMARAM BHEEM ASIFABAD
DISTRICT, TELANGANA STATE**
PROJECT DEMONSTRATION AND SCHOOL EXPERIMENT ACTIVITIES

Certificates

p-33

S.No.	Description	Details
1	Organization Name:	MULTIPURPOSE AWARENESS SOCIETY
2	Project Name:	ARTIFICIAL INTELLIGENCE BASED LINE FOLLOWING ROBOTS WITH (IOT)
3	Theme :	DEMONSTRATION ON MODEL OF LATEST TECHNOLOGY RELEVANT ROBOT AND AI
4	Sponsored by:	DEPARTMENT OF SCIENCE & TECHNOLOGY GOVERNMENT OF INDIA
5	School Name:	GOVT ASHRAM HIGH SCHOOL
6	Address School :	KAGAZNAGAR Dist: K.B. ASIFABAD
7	Signature of School principal with stamp	 HEADMASTER Govt. Ashram High School Kagaznagar Dist. Kumurambheem Asifabad
8	Mobile Number :	9440231297
9	Date of Program:	27/07/2019
10	Number of Student Participated	218
11	Model is Registered in School Science Book	Yes
12	Feed back of the School Science Teacher /Students	Good/Excellent
13	Signature of Project Trainer	
14	Signature of Project Investigator	

p-34

S.No.	Description	Details
1	Organization Name:	MULTIPURPOSE AWARENESS SOCIETY
2	Project Name:	ARTIFICIAL INTELLIGENCE BASED LINE FOLLOWING ROBOTS
3	Theme :	DEMONSTRATION ON MODEL OF LATEST TECHNOLOGY RELEVANT ROBOT AND AI
4	Sponsored by:	DEPARTMENT OF SCIENCE & TECHNOLOGY GOVERNMENT OF INDIA
5	School Name:	T.T.W.U.R.J.C - SIRPUR (T)
6	Address School :	at Kagaznagar Kagaznagar, Kumurambheem Asifabad - 504296
7	Signature of School principal with stamp	 6303632091
8	Mobile Number :	6303632091 PRINCIPAL T.T.W.U.R.J.C. (Girls) Sirpur-T, at Kagaznagar Dist. Kumurambheem Asif.
9	Date of Program:	29-7-2019
10	Number of Student Participated	280
11	Model is Registered in School Science Book	Yes
12	Feed back of the School Science Teacher /Students	Good/Excellent
13	Signature of Project Trainer	
14	Signature of Project Investigator	

p-35

S.No.	Description	Details
1	Organization Name:	MULTIPURPOSE AWARENESS SOCIETY
2	Project Name:	ARTIFICIAL INTELLIGENCE BASED LINE FOLLOWING ROBOTS WITH (IOT)
3	Theme :	DEMONSTRATION ON MODEL OF LATEST TECHNOLOGY RELEVANT ROBOT AND AI
4	Sponsored by:	DEPARTMENT OF SCIENCE & TECHNOLOGY GOVERNMENT OF INDIA
5	School Name:	ZPSS (Boys) Sirsilk, Kagaznagar.
6	Address School :	W. No. 1, KOSINI. Mdl: Kagaznagar. Dist: Kumurambheem Asifabad - 504296
7	Signature of School principal with stamp	 Headmaster, Gr-II (Guzr) ZPSS (B) Sirsilk, Kagaznagar Dist. K.B. Asifabad-504296
8	Mobile Number :	8074421641.
9	Date of Program:	30-07-2019
10	Number of Student Participated	265
11	Model is Registered in School Science Book	YES
12	Feed back of the School Science Teacher /Students	Good/Excellent
13	Signature of Project Trainer	
14	Signature of Project Investigator	

p-36

S.No.	Description	Details
1	Organization Name:	MULTIPURPOSE AWARENESS SOCIETY
2	Project Name:	ARTIFICIAL INTELLIGENCE BASED LINE FOLLOWING ROBOTS
3	Theme :	DEMONSTRATION ON MODEL OF LATEST TECHNOLOGY RELEVANT ROBOT AND AI
4	Sponsored by:	DEPARTMENT OF SCIENCE & TECHNOLOGY GOVERNMENT OF INDIA
5	School Name:	ZPSS Vempally
6	Address School :	Vill: Vempally Mandal: Sirpur (T) Dist. K.B. Asifabad.
7	Signature of School principal with stamp	 HEAD MASTER ZPSS VEMPALLY Mandal. SIRPUR-T Dist. Kumurambheem Asifabad
8	Mobile Number :	9989841309 I/c 9542259001 H/P
9	Date of Program:	31-7-2019
10	Number of Student Participated	100
11	Model is Registered in School Science Book	Yes
12	Feed back of the School Science Teacher /Students	Good/Excellent
13	Signature of Project Trainer	
14	Signature of Project Investigator	



ARTIFICIAL INTELLIGENCE BASED LINE FOLLOWER ROBOT FOR RURAL SCHOOL STUDENTS IN KOMARAM BHEEM ASIFABAD DISTRICT, TELANGANA STATE
PROJECT DEMONSTRATION AND SCHOOL EXPERIMENT ACTIVITIES

మల్టిపర్పస్ అవేర్నెస్ సొసైటీ

Sponsor : N.M.ICPS DIVISION, DST, GOVT. OF INDIA

- 1. లక్ష్యం:**
సాంకేతిక అభివృద్ధి, మూలక యోగంగా పనిచేసే విధానం. అంతర్జాల సమీక్షలతో పని నిరూపణ
- 2. ప్రాజెక్టు పేరు:**
ఆర్థిఫిషియల్ ఇంటెలిజెన్స్ బేస్డ్ లైన్ ఫాలోయింగ్ రోబోట్స్ విత్ ఐ.ఐ.ఐ
- 3. కావలసిన పరికరాలు:**
మెటల్స్ బ్లీడ్స్, రోబో బాడి, లాజిక్ బ్లీడ్స్, విద్యుత్ ఫుటము, గ్లూ, క్లిప్, వైర్లు, ఆర్డెర్ యుజ్డ్ ఫైల్స్ కంట్రిలరు, ఐ.ఐ.ఐ, సెన్సార్లు, ఇయస్.పి. అంతర్జాల వలకరం మొదలయ్యారు.
- 4. లైన్ ఫాలోయింగ్ లంబ్ ఏమిటి?**
ఇది ఒక సాంకేతిక అభివృద్ధి విధానం కింది వస్తువు. లైన్ కంటికి కనపడటం ఉంటుంది ఒక నల్లని లైన్ ఆకారం ప్రకారం ఆ రోబో దారిని ఫాలో అవుతుంది నెలపంది.
- 5. ఉపయోగాలు / ఉపయోగించు ప్రదేశాలు:**
లోయర్ విద్యాలకు, అంతర్జాల సెన్సార్లు అమెజాన్, ఫ్లిప్కార్డ్ మొదలయ్యారు. చాలా చూపుటకు, మెకానిక్ టీచింగ్ సర్టిఫికేట్లు.
- 6. IR సెన్సార్ పనితీరు:**
ఇన్ఫ్రారెడ్ లైట్ లను కంటికి కనపడని కాంతిని విద్యుత్తుకు మలయు ప్రతిబింబించిన కిరణాలను గమనిస్తుంది పనిచేస్తుంటాయి. గమనించిన సంగతుల వల్ల కంప్యూటర్ ఆర్డెర్ యుజ్డ్ కి వస్తుంటుంది.
- 7. UNO మైక్రో కంట్రోల్:**
మైక్రో కంట్రోల్ ఒక మెదడు లాంటి విధానంతో పనిచేస్తుంది. అనే ప్రాజెక్టు పనిచేసే ఒక ముఖ్యమం దుంట్లము.
IR సెన్సార్ వంటివి వల్ల కంటికి కనపడని కాంతిని విద్యుత్తుకు మలయు ప్రతిబింబించిన కిరణాలను గమనిస్తుంది పనిచేస్తుంటాయి. గమనించిన సంగతుల వల్ల కంప్యూటర్ ఆర్డెర్ యుజ్డ్ కి వస్తుంటుంది.
- 8. బాటిక్ డోర్లు:**
సంకేతాలు అందుకున్న తరువాత ఇది మెదడు కంట్రోల్ చేస్తుంది లేదా ఎదముకు నడుపుతుంది.
- 9. అంతర్జాల EPS డిజైన్:**
రోబో మొదలు అయిన విషయం, రోబో డిజైన్లు చేసే విధానం "బిల్ నెట్" అనే అండ్రియూడ్. అనే ద్వారా తెలియపరుచును. రోబో మలయు అవల WiFi సిస్టమ్లో అనుసంధానించబడును.



విద్యార్థులకు రోబోటిక్స్ పై అవగాహన కల్పిస్తున్న సొసైటీ ప్రతినిధి నాగేశ్వరరావు

సాంకేతిక విద్యపై పట్టు సాధించాలి

కాగజీనగర్, న్యూనీట్ : మారుతున్న పరిస్థితులకు అనుగుణంగా విద్యార్థులు శాస్త్ర సాంకేతిక విద్యపై మరింత పట్టు సాధించాలని మల్లిపర్వస్ అవేర్నెస్ సొసైటీ ప్రెసిడెంట్ జోడ నాగేశ్వరరావు అన్నారు. సోమవారం స్థానిక తెలంగాణ ట్రైబల్ వెల్ఫేర్ అసోసియేషన్ రెసిడెన్షియల్ జూనియర్ కళాశాల అండ్ పాఠశాలలో కంప్యూటర్ ఆర్టిఫిషియల్ ఇంటెలిజెన్స్ రోబోటిక్స్ అంశంపై శిక్షణ నిర్వహించారు. ఈ సందర్భంగా ఆయన మాట్లాడుతూ రోబోటిక్స్ అంశాలపై విద్యార్థులకు వివరించారు. కార్యక్రమంలో పాఠశాల ఉపాధ్యాయులు, విద్యార్థినులు పాల్గొన్నారు.

: 30/07/2019 EditionName : TELANGANA(KUMURAM BHEEM) PageNo : Pa

Certificates



రోబోటిక్స్ పై అవగాహన కల్పిస్తున్న నిర్వాహకుడు

టిక్కాలజీ పై అవగాహన పెంచుకోవాలి

కాగజీనగర్, వెలుగు: టిక్కాలజీ సంబంధిత అంశాలపై స్టూడెంట్స్ అవగాహన పెంచుకోవాలని మల్లిపర్వస్ సొసైటీ అధ్యక్షుడు జోడ నాగేశ్వరరావు అన్నారు. సోమవారం కాగజీనగర్ పట్టణంలోని బ్రెజర్ వెల్ఫేర్ అసోసియేషన్ రెసిడెన్షియల్ జూనియర్ కాలేజీలో 'కంప్యూటర్ హార్టిఫిషియల్ ఇంటెలిజెన్స్, రోబోటిక్స్' అనే అంశంపై ఆయన స్టూడెంట్స్ కు అవగాహన కల్పించారు. ఈ సందర్భం

గా మాట్లాడుతూ స్టూడెంట్స్లో ఉన్న ఆసక్తిని పెంపొందించి రోబోటిక్స్ విషయంలో అవగాహన కల్పించి సూత్ర సాధన అభివృద్ధిలకు అవకాశం ఇచ్చే ప్రక్రియ కనసాగితో ఉండాలని, జిల్లాలోని 36 గిరిజన స్కూళ్లకు ప్రత్యేకంగా రోబోటిక్స్ కిట్స్ను అందిస్తామన్నారు. ఈ కార్యక్రమంలో ప్రిన్సిపల్ రమ్య కృష్ణ, డిప్యూటీ ప్రాజెక్ట్ డైరెక్టర్ బానోనా నాగేష్ తదితరులు పాల్గొన్నారు.



Rural tribal school kids exposed to AI, robotics

Asifabad: Multipurpose awareness society organised free computer awareness programmes giving students a basic knowledge about artificial intelligence along with robotics, smart home for rural tribal school kids in Asifabad PHS School and Government Junior College, Komata Mandal during the whole month of June. The programme was attended by more than 400 rural tribal school students along with their teachers and school principal. The multipurpose awareness society has announced to conduct similar programs in 25 more schools in various

mandals across Asifabad. Speaking to The Hans India project investigator Boda Nagewara Basu said, "We are planning to organise more such science activities in near future for the learning of rural school kids. Those who attended the programme have now basic knowledge of building a robot along with other electronics, computer, and artificial intelligence. This will surely boost their morale and in future, we might see some rural innovators coming up with some amazing innovations. The next batch of schools will start this month soon" he said.





MULTIPURPOSE AWARENESS SOCIETY



SPONSOR BY :

NATIONAL MISSION INTERDISCIPLINARY CYBER-PHYSICAL SYSTEMS (NM-ICPS) DIVISION
DEPARTMENT OF SCIENCE & TECHNOLOGY
GOVERNMENT OF INDIA

Certificate of Participation

This is to Certify that Kumari / Kumar

Class.....ofschool

has Participated in Demonstration Experiment on Artificial Intelligence Based Line Following Robotic under Schedule Tribes

(ST category) under ICPS Program Supported by Ministry of Science and Technology, Department of Science and Technology

Government of India. Organized by Multipurpose Awareness Society, Hyderabad On

PROJECT TRAINER

www.masindia.org

PROJECT INVESTIGATOR

Poster



MULTIPURPOSE AWARENESS SOCIETY



SPONSOR BY :
NATIONAL MISSION INTERDISCIPLINARY CYBER-PHYSICAL SYSTEMS (NM-ICPS) DIVISION
DEPARTMENT OF SCIENCE & TECHNOLOGY
GOVERNMENT OF INDIA

కంప్యూటర్ ఒక ఎలక్ట్రానిక్ పరికరం.

కంప్యూటర్, ఆర్టిఫిషియల్ ఇంటెలిజెన్స్ మరియు రంబోట్స్ నేర్చుకుంటూ
నైపుణ్యంతో పాటు, ఉపాధిని పొందుతారు.
సైన్స్ అభివృద్ధి, ఆవిష్కరణల వైపు అడుగులు వేద్దాం.



Basic parts of a Computer
కంప్యూటర్ భాగాలు



ఆధునిక రోబోట్లు

PRINTED AND PUBLISHED BY
MULTIPURPOSE AWARENESS SOCIETY
Hyderabad, Telangana.
website: www.masindia.org

Robots





ARTIFICIAL INTELLIGENCE BASED LINE FOLLOWER ROBOT FOR RURAL SCHOOL STUDENTS IN KOMARAM BHEEM ASIFABAD DISTRICT, TELANGANA STATE
PROJECT DEMONSTRATION AND SCHOOL EXPERIMENT ACTIVITIES

P-37

S.No.	Description	Details
1	Organization Name:	MULTIPURPOSE AWARENESS SOCIETY
2	Project Name:	ARTIFICIAL INTELLIGENCE BASED LINE FOLLOWING ROBOTS
3	Theme:	DEMONSTRATION ON MODEL OF LATEST TECHNOLOGY RELEVANT ROBOT AND AI
4	Sponsored by:	DEPARTMENT OF SCIENCE & TECHNOLOGY GOVERNMENT OF INDIA
5	School Name:	MP UPS Easgaon
6	Address School:	Easgaon Mandal - Kaghaznagar Dist. Komaram Bheem (Asifabad) Pin. 504296
7	Signature of School principal with stamp	<i>[Signature]</i> Head Master M.P.U.S. Easgaon
8	Mobile Number:	9010263074
9	Date of Program:	01-03-2019
10	Number of Student Participated	151
11	Model is Registered in School Science Book	Yes
12	Feed back of the School Science Teacher /Students	Good/Excellent
13	Signature of Project Trainer	<i>[Signature]</i>
14	Signature of Project Investigator	<i>[Signature]</i>

P-38

S.No.	Description	Details
1	Organization Name:	MULTIPURPOSE AWARENESS SOCIETY
2	Project Name:	ARTIFICIAL INTELLIGENCE BASED LINE FOLLOWING ROBOTS
3	Theme:	DEMONSTRATION ON MODEL OF LATEST TECHNOLOGY RELEVANT ROBOT AND AI
4	Sponsored by:	DEPARTMENT OF SCIENCE & TECHNOLOGY GOVERNMENT OF INDIA
5	School Name:	M.P.S Sirsilk Ward no-2
6	Address School:	Md-1 - Kaghaznagar Dist - Komarambheem (Asf)
7	Signature of School principal with stamp	<i>[Signature]</i> A. Chandrakala, Jc/Hem Sr Teacher School Management Committee M.P.S. SIRSILK Kaghaznagar Dist. Asifabad
8	Mobile Number:	9852284824
9	Date of Program:	01/03/2019
10	Number of Student Participated	145
11	Model is Registered in School Science Book	Yes
12	Feed back of the School Science Teacher /Students	Good/Excellent
13	Signature of Project Trainer	<i>[Signature]</i>
14	Signature of Project Investigator	<i>[Signature]</i>

-Ackala
Head Master / Sr Teacher
School Management Committee
M.P.S. SIRSILK
Kaghaznagar Dist. Asifabad

Certificates

P-39

S.No.	Description	Details
1	Organization Name:	MULTIPURPOSE AWARENESS SOCIETY
2	Project Name:	ARTIFICIAL INTELLIGENCE BASED LINE FOLLOWING ROBOTS
3	Theme:	DEMONSTRATION ON MODEL OF LATEST TECHNOLOGY RELEVANT ROBOT AND AI
4	Sponsored by:	DEPARTMENT OF SCIENCE & TECHNOLOGY GOVERNMENT OF INDIA
5	School Name:	Govt. P.S. Sirsilk
6	Address School:	Sirsilk, Subashchandrababu Colony, Kaghaznagar. 504296
7	Signature of School principal with stamp	<i>[Signature]</i> HEADMASTER GOVT. P.S. SIRSILK Subash Chandrababu Dist. K.B. Asifabad
8	Mobile Number:	9491469419
9	Date of Program:	01-03-2019
10	Number of Student Participated	124
11	Model is Registered in School Science Book	Yes
12	Feed back of the School Science Teacher /Students	Good/Excellent
13	Signature of Project Trainer	<i>[Signature]</i>
14	Signature of Project Investigator	<i>[Signature]</i>

P-40

S.No.	Description	Details
1	Organization Name:	MULTIPURPOSE AWARENESS SOCIETY
2	Project Name:	ARTIFICIAL INTELLIGENCE BASED LINE FOLLOWING ROBOTS
3	Theme:	DEMONSTRATION ON MODEL OF LATEST TECHNOLOGY RELEVANT ROBOT AND AI
4	Sponsored by:	DEPARTMENT OF SCIENCE & TECHNOLOGY GOVERNMENT OF INDIA
5	School Name:	Z.P.S Chintkaguda (K)
6	Address School:	Chintkaguda (K), G.P. Chintkaguda Man. Kaghaznagar.
7	Signature of School principal with stamp	<i>[Signature]</i> HEADMASTER Z.P. SECONDARY SCHOOL Chintkaguda (K) - 1st phase Kaghaznagar Dist. Asifabad
8	Mobile Number:	7382621371
9	Date of Program:	01-03-2019
10	Number of Student Participated	150
11	Model is Registered in School Science Book	Yes
12	Feed back of the School Science Teacher /Students	Good/Excellent
13	Signature of Project Trainer	<i>[Signature]</i>
14	Signature of Project Investigator	<i>[Signature]</i>



ARTIFICIAL INTELLIGENCE BASED LINE FOLLOWER ROBOT FOR RURAL SCHOOL STUDENTS IN KOMARAM BHEEM ASIFABAD DISTRICT, TELANGANA STATE
PROJECT DEMONSTRATION AND SCHOOL EXPERIMENT ACTIVITIES

SCHOOL AWARENESS PROGRAMS REPORT FORM

Organization Name: MULTIPURPOSE AWARENESS SOCIETY

Project Name: ARTIFICIAL INTELLIGENCE BASED LINE FOLLOWING ROBOTS

Theme: DEMONSTRATION ON MODEL OF LATEST TECHNOLOGY RELEVANT ROBOT AND AI

Sponsored by: DEPARTMENT OF SCIENCE & TECHNOLOGY GOVERNMENT OF INDIA

School Name: Govt High School Engaon No-3

Address School: Govt High school Engaon no-3 P.O. Engaon Dist. Kumrambheem Asifab

Signature of School principal with stamp: [Stamp]

Mobile Number: 97676

Date of Program: 1-08-19

Number of Student Participated: 306

Model is Registered in School Science Book: Yes

Feed back of the School Science Teacher / Students: Good/Excellent

Signature of Project Trainer: [Signature]

Signature of Project Investigator: [Signature]

SCHOOL AWARENESS PROGRAMS REPORT FORM

Organization Name: MULTIPURPOSE AWARENESS SOCIETY

Project Name: ARTIFICIAL INTELLIGENCE BASED LINE FOLLOWING ROBOTS

Theme: DEMONSTRATION ON MODEL OF LATEST TECHNOLOGY RELEVANT ROBOT AND AI

Sponsored by: DEPARTMENT OF SCIENCE & TECHNOLOGY GOVERNMENT OF INDIA

School Name: Govt High school (old) Kaghaznagar

Address School: W-NO: 11 Near Rajeev Chowk, Kaghaznagar

Signature of School principal with stamp: [Stamp]

Mobile Number: 9492568315

Date of Program: 1-08-2019

Number of Student Participated: 300

Model is Registered in School Science Book: Yes

Feed back of the School Science Teacher / Students: Good/Excellent

Signature of Project Trainer: [Signature]

Signature of Project Investigator: [Signature]

Certificates

SCHOOL AWARENESS PROGRAMS REPORT FORM

Organization Name: MULTIPURPOSE AWARENESS SOCIETY

Project Name: ARTIFICIAL INTELLIGENCE BASED LINE FOLLOWING ROBOTS

Theme: DEMONSTRATION ON MODEL OF LATEST TECHNOLOGY RELEVANT ROBOT AND AI

Sponsored by: DEPARTMENT OF SCIENCE & TECHNOLOGY GOVERNMENT OF INDIA

School Name: Z.P.S.S Petrol Pump, SKZR

Address School: Post: Kaghaznagar (504296) Dist: Kumrambheem

Signature of School principal with stamp: [Stamp]

Mobile Number: 9908149235

Date of Program: 1/8/2019

Number of Student Participated: 250

Model is Registered in School Science Book: Yes

Feed back of the School Science Teacher / Students: Real Robo be Existed very interest

Signature of Project Trainer: [Signature]

Signature of Project Investigator: [Signature]

SCHOOL AWARENESS PROGRAMS REPORT FORM

Organization Name: MULTIPURPOSE AWARENESS SOCIETY

Project Name: ARTIFICIAL INTELLIGENCE BASED LINE FOLLOWING ROBOTS

Theme: DEMONSTRATION ON MODEL OF LATEST TECHNOLOGY RELEVANT ROBOT AND AI

Sponsored by: DEPARTMENT OF SCIENCE & TECHNOLOGY GOVERNMENT OF INDIA

School Name: GOVT HIGH SCHOOL (NEW) RRO-COLANY - KAGHAZNAGAR

Address School: Ward No 7

Signature of School principal with stamp: [Stamp]

Mobile Number: 9908748720

Date of Program: 1/08/2019

Number of Student Participated: 127

Model is Registered in School Science Book: Yes

Feed back of the School Science Teacher / Students: Good/Excellent

Signature of Project Trainer: [Signature]

Signature of Project Investigator: [Signature]



ARTIFICIAL INTELLIGENCE BASED LINE FOLLOWER ROBOT FOR RURAL SCHOOL STUDENTS IN KOMARAM BHEEM ASIFABAD DISTRICT, TELANGANA STATE
PROJECT DEMONSTRATION AND SCHOOL EXPERIMENT ACTIVITIES

SCHOOL AWARENESS PROJECT MONITOR FORM P-45

Organization Name: MULTIPURPOSE AWARENESS SOCIETY
 Project Name: ARTIFICIAL INTELLIGENCE BASED LINE FOLLOWING ROBOTS
 Topic: DEMONSTRATION ON MODEL OF LATEST TECHNOLOGY RELEVANT ROBOT AND AI
 Sponsored by: DEPARTMENT OF SCIENCE & TECHNOLOGY GOVERNMENT OF INDIA
 School Name: M.P.P.S. Bodampally
 Address School: Village - Bodampally Kotala, K.B.
 Signature of School principal with stamp: [Stamp] Chairman Convener/HM School Management Committee MPPS, Bodampally, Md. Kotala, Dist. Kumaram Bheem Asifabad.
 Mobile Number: 7095419133
 Date of Program: 3/08/19
 Number of Students Participated: 3/08/19 148
 Model is Displayed in School Science Book: YES
 Cover back of the School Science Book is marked: Good/Excellent
 Signature of Project Investigator: [Signature]

SCHOOL AWARENESS PROJECT MONITOR FORM P-46

Organization Name: MULTIPURPOSE AWARENESS SOCIETY
 Project Name: ARTIFICIAL INTELLIGENCE BASED LINE FOLLOWING ROBOTS
 Topic: DEMONSTRATION ON MODEL OF LATEST TECHNOLOGY RELEVANT ROBOT AND AI
 Sponsored by: DEPARTMENT OF SCIENCE & TECHNOLOGY GOVERNMENT OF INDIA
 School Name: MPPS Talodi
 Address School: MPPS Talodi, MP. Kotala, (Dist) Kumram Bheem (Asf)
 Signature of School principal with stamp: [Stamp] Head Master M.P.P.S. TALODI, MP. KOTALA
 Mobile Number: 9398506881
 Date of Program: 03-08-2019
 Number of Students Participated: 30
 Model is Displayed in School Science Book: YES
 Cover back of the School Science Book is marked: Good/Excellent
 Signature of Project Investigator: [Signature]

Certificates

SCHOOL AWARENESS PROJECT MONITOR FORM P-47

Organization Name: MULTIPURPOSE AWARENESS SOCIETY
 Project Name: ARTIFICIAL INTELLIGENCE BASED LINE FOLLOWING ROBOTS
 Topic: DEMONSTRATION ON MODEL OF LATEST TECHNOLOGY RELEVANT ROBOT AND AI
 Sponsored by: DEPARTMENT OF SCIENCE & TECHNOLOGY GOVERNMENT OF INDIA
 School Name: T.W. DISHA MODEL E/M SCHOOL
 Address School: Village: Gurudupeta Kotala MNDL: Asifabad (KB) Dist: Asifabad (KB)
 Signature of School principal with stamp: [Stamp] A. Nandaram HM
 Mobile Number: 9182733659
 Date of Program: 05-08-2019
 Number of Students Participated: 130
 Model is Displayed in School Science Book: YES
 Cover back of the School Science Book is marked: Good/Excellent
 Signature of Project Investigator: [Signature]

SCHOOL AWARENESS PROJECT MONITOR FORM P-48

Organization Name: MULTIPURPOSE AWARENESS SOCIETY
 Project Name: ARTIFICIAL INTELLIGENCE BASED LINE FOLLOWING ROBOTS
 Topic: DEMONSTRATION ON MODEL OF LATEST TECHNOLOGY RELEVANT ROBOT AND AI
 Sponsored by: DEPARTMENT OF SCIENCE & TECHNOLOGY GOVERNMENT OF INDIA
 School Name: ZPSS Gundairpet
 Address School: Gundairpet, Kotala mandal, Kumram Bheem Asifabad, Telangana - 504299
 Signature of School principal with stamp: [Stamp] HEAD MASTER ZPSS GUNDAIPE Mandali KOTALA Dist. Kumram Bheem-Asifabad
 Mobile Number: 9492519410
 Date of Program: 05/08/2019
 Number of Students Participated: 53
 Model is Displayed in School Science Book: YES
 Cover back of the School Science Book is marked: Good/Excellent
 Signature of Project Investigator: [Signature]



**ARTIFICIAL INTELLIGENCE BASED LINE FOLLOWER ROBOT
FOR RURAL SCHOOL STUDENTS IN KOMARAM BHEEM ASIFABAD
DISTRICT, TELANGANA STATE**
PROJECT DEMONSTRATION AND SCHOOL EXPERIMENT ACTIVITIES

SCHOOL AWARENESS SOCIETY REGISTRATION FORM

Organization Name: MULTIPURPOSE AWARENESS SOCIETY
Project Name: ARTIFICIAL INTELLIGENCE BASED LINE FOLLOWING ROBOTS
Theme: DEMONSTRATION ON MODEL OF LATEST TECHNOLOGY RELEVANT ROBOT AND AI
Sponsored by: DEPARTMENT OF SCIENCE & TECHNOLOGY GOVERNMENT OF INDIA
School Name: MPPS - IPPALAGUDA
Address School: Vill. Bodhanpally, Md: Koutala
Dist. Komarambheem (ASF)
Signature of School principal with stamp: I. C. S. Iyada, HEAD MASTER, MPPS, IPPALAGUDA, Mandal Koutala, Dist. Komarambheem, Tel. 7613986197
Date of Program: 05-08-2019
Number of School Participants: 29
Model is kept in School Science Book: Yes
Free back of the School Science Book: Yes
Signature of Project Investigator: Beej

SCHOOL AWARENESS SOCIETY REGISTRATION FORM

Organization Name: MULTIPURPOSE AWARENESS SOCIETY
Project Name: ARTIFICIAL INTELLIGENCE BASED LINE FOLLOWING ROBOTS
Theme: DEMONSTRATION ON MODEL OF LATEST TECHNOLOGY RELEVANT ROBOT AND AI
Sponsored by: DEPARTMENT OF SCIENCE & TECHNOLOGY GOVERNMENT OF INDIA
School Name: Govt. Twp. Shivalingapur & Shivalingapur Md: Koutala
Dist. Komarambheem, ASF
Signature of School principal with stamp: Chairman Convener of School Management Committee, Govt. Twp. Primary School, Shivalingapur, Md. Koutala, Dist. ASF, 9553017629.
Date of Program: 05-08-2019
Number of School Participants: 111
Model is kept in School Science Book: Yes
Free back of the School Science Book: Yes
Signature of Project Investigator: Beej

Certificates

SCHOOL AWARENESS SOCIETY REGISTRATION FORM

Organization Name: MULTIPURPOSE AWARENESS SOCIETY
Project Name: ARTIFICIAL INTELLIGENCE BASED LINE FOLLOWING ROBOTS
Theme: DEMONSTRATION ON MODEL OF LATEST TECHNOLOGY RELEVANT ROBOT AND AI
Sponsored by: DEPARTMENT OF SCIENCE & TECHNOLOGY GOVERNMENT OF INDIA
School Name: MPPS Gundaipet
Address School: MPPS, Gundaipet, Vill Gundaipet md: Koutala, Dist. Komarambheem (ASF)
Signature of School principal with stamp: I. C. S. Iyada, HEAD MASTER, MPPS, GUNDAI PET, Mandal Koutala, Dist. Komarambheem, Tel. 9177273784
Date of Program: 05/08/2019
Number of School Participants: 140
Model is kept in School Science Book: Yes
Free back of the School Science Book: Yes
Signature of Project Investigator: Beej

SCHOOL AWARENESS SOCIETY REGISTRATION FORM

Organization Name: MULTIPURPOSE AWARENESS SOCIETY
Project Name: ARTIFICIAL INTELLIGENCE BASED LINE FOLLOWING ROBOTS
Theme: DEMONSTRATION ON MODEL OF LATEST TECHNOLOGY RELEVANT ROBOT AND AI
Sponsored by: DEPARTMENT OF SCIENCE & TECHNOLOGY GOVERNMENT OF INDIA
School Name: MPPS Kannepalli
Address School: M. Koutala, Kannepalli
Signature of School principal with stamp: Anil Kumar, HEAD MASTER, MPPS SCHOOL, KANNEPALLI, Mandal Koutala, Dist. Komarambheem, Tel. 9963114317 / 8919345258
Date of Program: 6-Aug-19
Number of School Participants: 42
Model is kept in School Science Book: Yes
Free back of the School Science Book: Yes
Signature of Project Investigator: Beej



ARTIFICIAL INTELLIGENCE BASED LINE FOLLOWER ROBOT FOR RURAL SCHOOL STUDENTS IN KOMARAM BHEEM ASIFABAD DISTRICT, TELANGANA STATE
PROJECT DEMONSTRATION AND SCHOOL EXPERIMENT ACTIVITIES

SCHOOL AWARENESS PROGRAMS REGISTRATION FOAM

S.No.	Description	Details
1	Organization Name:	MULTIPURPOSE AWARENESS SOCIETY
2	Project Name:	ARTIFICIAL INTELLIGENCE BASED LINE FOLLOWING ROBOTS
3	Theme :	DEMONSTRATION ON MODEL OF LATEST TECHNOLOGY RELEVANT ROBOT AND AI
4	Sponsored by:	DEPARTMENT OF SCIENCE & TECHNOLOGY GOVERNMENT OF INDIA
5	School Name:	MP. UPS : Gudlaboni
6	Address School:	Gudlaboni Md: Koutala Dist: Kumurambheem
7	Signature of School principal with stamp	IC HEAD MASTER MP UPS Gudlaboni, Md: Koutala, Dist: Kumaram Bheem
8	Mobile Number :	8999261009
9	Date of Program:	6/8/2019
10	Number of Student Participated	35/54
11	Model is Registered in School Science Book	Yes
12	Feed back of the School Science Teacher /Students	Good/Excellent
13	Signature of Project Trainer	MS
14	Signature of Project Investigator	Billy

SCHOOL AWARENESS PROGRAMS REGISTRATION FOAM

S.No.	Description	Details
1	Organization Name:	MULTIPURPOSE AWARENESS SOCIETY
2	Project Name:	ARTIFICIAL INTELLIGENCE BASED LINE FOLLOWING ROBOTS
3	Theme :	DEMONSTRATION ON MODEL OF LATEST TECHNOLOGY RELEVANT ROBOT AND AI
4	Sponsored by:	DEPARTMENT OF SCIENCE & TECHNOLOGY GOVERNMENT OF INDIA
5	School Name:	Gout. AHS Mogad Dhagad
6	Address School:	Vill: Mogad Dhagad, Mand: Koutala Dist: K.B. Asifabad.
7	Signature of School principal with stamp	Signature of School principal with stamp
8	Mobile Number :	
9	Date of Program:	06-08-2019
10	Number of Student Participated	180
11	Model is Registered in School Science Book	Yes
12	Feed back of the School Science Teacher /Students	Good/Excellent
13	Signature of Project Trainer	MS
14	Signature of Project Investigator	Billy

Certificates

SCHOOL AWARENESS PROGRAMS REGISTRATION FOAM

S.No.	Description	Details
1	Organization Name:	MULTIPURPOSE AWARENESS SOCIETY
2	Project Name:	ARTIFICIAL INTELLIGENCE BASED LINE FOLLOWING ROBOTS
3	Theme :	DEMONSTRATION ON MODEL OF LATEST TECHNOLOGY RELEVANT ROBOT AND AI
4	Sponsored by:	DEPARTMENT OF SCIENCE & TECHNOLOGY GOVERNMENT OF INDIA
5	School Name:	Z.P.S.S LOHAVELLY, Sirpur (T)
6	Address School:	Vill: LOHAVELLY, Md: Sirpur (T) Dist: KOMURAMBHEEM ASIFABAD 504299.
7	Signature of School principal with stamp	HEAD MASTER Z.P.S.S. Loनावelly Md. Sirpur-T Dist. Kumurambheem Asf.
8	Mobile Number :	9705773816
9	Date of Program:	6/08/2019
10	Number of Student Participated	35
11	Model is Registered in School Science Book	Yes
12	Feed back of the School Science Teacher /Students	Good/Excellent
13	Signature of Project Trainer	K. K. K. K.
14	Signature of Project Investigator	Billy

SCHOOL AWARENESS PROGRAMS REGISTRATION FOAM

S.No.	Description	Details
1	Organization Name:	MULTIPURPOSE AWARENESS SOCIETY
2	Project Name:	ARTIFICIAL INTELLIGENCE BASED LINE FOLLOWING ROBOTS
3	Theme :	DEMONSTRATION ON MODEL OF LATEST TECHNOLOGY RELEVANT ROBOT AND AI
4	Sponsored by:	DEPARTMENT OF SCIENCE & TECHNOLOGY GOVERNMENT OF INDIA
5	School Name:	T.W.P.S K-B Colony Mogaddhagad.
6	Address School:	Village: Mogaddhagad. mand: Koutala Dist: Kumurambheem Asifabad.
7	Signature of School principal with stamp	HEAD MASTER T.W.P.S. K.B. Colony, Mogaddhagad, Dist. Kumurambheem Asifabad.
8	Mobile Number :	9441101226
9	Date of Program:	06-08-2019
10	Number of Student Participated	122
11	Model is Registered in School Science Book	Yes
12	Feed back of the School Science Teacher /Students	Good/Excellent
13	Signature of Project Trainer	MS
14	Signature of Project Investigator	Billy



**ARTIFICIAL INTELLIGENCE BASED LINE FOLLOWER ROBOT
FOR RURAL SCHOOL STUDENTS IN KOMARAM BHEEM ASIFABAD
DISTRICT, TELANGANA STATE
PROJECT DEMONSTRATION AND SCHOOL EXPERIMENT ACTIVITIES**

p-58

SCHOOL AWARENESS PROGRAMS REGISTRATION FOAM

S.No.	Description	Details
1	Organization Name:	MULTIPURPOSE AWARENESS SOCIETY
2	Project Name:	ARTIFICIAL INTELLIGENCE BASED LINE FOLLOWING ROBOTS
3	Theme :	DEMONSTRATION ON MODEL OF LATEST TECHNOLOGY RELEVANT ROBOT AND AI
4	Sponsored by:	DEPARTMENT OF SCIENCE & TECHNOLOGY GOVERNMENT OF INDIA
5	School Name:	TSWRES Kagaznagar [gulu]
6	Address School :	Sisapur [r] Vill: Sisapur [r] Md: Sisapur [r] Dist: Komurambheem Asifabad 504299
7	Signature of School principal with stamp	 PRINCIPAL TS W Res. SCHOOL KAGHAZNAGAR
8	Mobile Number :	7995010573
9	Date of Program:	6/08/2019
10	Number of Student Participated	50
11	Model is Registered in School Science Book	Yes
12	Feed back of the School Science Teacher /Students	Good/Excellent
13	Signature of Project Trainer	Khazari
14	Signature of Project Investigator	Bell

p-58

SCHOOL AWARENESS PROGRAMS REGISTRATION FOAM

S.No.	Description	Details
1	Organization Name:	MULTIPURPOSE AWARENESS SOCIETY
2	Project Name:	ARTIFICIAL INTELLIGENCE BASED LINE FOLLOWING ROBOTS
3	Theme :	DEMONSTRATION ON MODEL OF LATEST TECHNOLOGY RELEVANT ROBOT AND AI
4	Sponsored by:	DEPARTMENT OF SCIENCE & TECHNOLOGY GOVERNMENT OF INDIA
5	School Name:	MPPS PARDI
6	Address School :	Vill: Paodi , Md: Koutala Dist: Komurambheem (Asf)
7	Signature of school principal with stamp	 HEAD MASTER MPPS PARDI K.P.P.S. PARDI
8	Mobile Number :	9808613250
9	Date of Program:	07-08-2019
10	Number of Student Participated	48
11	Model is Registered in School Science Book	Yes
12	Feed back of the School Science Teacher /Students	Good/Excellent
13	Signature of Project Trainer	NA
14	Signature of Project Investigator	Bell

Certificates

p-59

SCHOOL AWARENESS PROGRAMS REGISTRATION FOAM

School code - 36021101003

S.No.	Description	Details
1	Organization Name:	MULTIPURPOSE AWARENESS SOCIETY
2	Project Name:	ARTIFICIAL INTELLIGENCE BASED LINE FOLLOWING ROBOTS
3	Theme :	DEMONSTRATION ON MODEL OF LATEST TECHNOLOGY RELEVANT ROBOT AND AI
4	Sponsored by:	DEPARTMENT OF SCIENCE & TECHNOLOGY GOVERNMENT OF INDIA
5	School Name:	mpups mogad dafod
6	Address School :	mpups mogad dafod Md: Koutala Dist: Komurambheem
7	Signature of School principal with stamp	 HEAD MASTER MPPS, MOGAD DHAGAD MP: Koutala, Dist: ADB
8	Mobile Number :	9676890710
9	Date of Program:	07/08/2019
10	Number of Student Participated	145
11	Model is Registered in School Science Book	Yes
12	Feed back of the School Science Teacher /Students	Good/Excellent
13	Signature of Project Trainer	NA
14	Signature of Project Investigator	Bell

p-60

SCHOOL AWARENESS PROGRAMS REGISTRATION FOAM

S.No.	Description	Details
1	Organization Name:	MULTIPURPOSE AWARENESS SOCIETY
2	Project Name:	ARTIFICIAL INTELLIGENCE BASED LINE FOLLOWING ROBOTS
3	Theme :	DEMONSTRATION ON MODEL OF LATEST TECHNOLOGY RELEVANT ROBOT AND AI
4	Sponsored by:	DEPARTMENT OF SCIENCE & TECHNOLOGY GOVERNMENT OF INDIA
5	School Name:	Mpps, Shirshah
6	Address School :	visshirsh. Mn: Koutala, di: Komurambheem (Asf)
7	Signature of School principal with stamp	 HEAD MASTER MPPS
8	Mobile Number :	9692903609
9	Date of Program:	07-08-2019
10	Number of Student Participated	50
11	Model is Registered in School Science Book	Yes
12	Feed back of the School Science Teacher /Students	Good/Excellent
13	Signature of Project Trainer	NA
14	Signature of Project Investigator	Bell



**ARTIFICIAL INTELLIGENCE BASED LINE FOLLOWER ROBOT
FOR RURAL SCHOOL STUDENTS IN KOMARAM BHEEM ASIFABAD
DISTRICT, TELANGANA STATE
PROJECT DEMONSTRATION AND SCHOOL EXPERIMENT ACTIVITIES**

p-65

S.No.	Description	Details
1	Organization Name:	MULTIPURPOSE AWARENESS SOCIETY
2	Project Name:	ARTIFICIAL INTELLIGENCE BASED LINE FOLLOWING ROBOTS
3	Theme :	DEMONSTRATION ON MODEL OF LATEST TECHNOLOGY RELEVANT ROBOT AND AI
4	Sponsored by:	DEPARTMENT OF SCIENCE & TECHNOLOGY GOVERNMENT OF INDIA
5	School Name:	mpps Bheeroheti mdl Koutala
6	Address School :	mpps Bheeroheti mdl Koutala Dist. Komurambheem
7	Signature of School principal with stamp	HEAD MASTER M.P.S. BHEEROHETI Mdl: Koutala Dist. Komurambheem A.P.
8	Mobile Number :	8985632399
9	Date of Program:	07-08-2019
10	Number of Student Participated	114
11	Model is Registered in School Science Book	Yes
12	Feed back of the School Science Teacher /Students	Good/Excellent
13	Signature of Project Trainer	MS
14	Signature of Project Investigator	Beel

p-66

S.No.	Description	Details
1	Organization Name:	MULTIPURPOSE AWARENESS SOCIETY
2	Project Name:	ARTIFICIAL INTELLIGENCE BASED LINE FOLLOWING ROBOTS
3	Theme :	DEMONSTRATION ON MODEL OF LATEST TECHNOLOGY RELEVANT ROBOT AND AI
4	Sponsored by:	DEPARTMENT OF SCIENCE & TECHNOLOGY GOVERNMENT OF INDIA
5	School Name:	mpps Vajram mdl Koutala
6	Address School :	mpps Vajram mdl Koutala Dist. Komurambheem 504299
7	Signature of School principal with stamp	HEAD MASTER M.P.S. VAJRAM Mdl: Koutala Dist. Komurambheem A.P.
8	Mobile Number :	8985632399
9	Date of Program:	07-08-2019
10	Number of Student Participated	104
11	Model is Registered in School Science Book	Yes
12	Feed back of the School Science Teacher /Students	Good/Excellent
13	Signature of Project Trainer	MS
14	Signature of Project Investigator	Beel

Certificates

p-67

S.No.	Description	Details
1	Organization Name:	MULTIPURPOSE AWARENESS SOCIETY
2	Project Name:	ARTIFICIAL INTELLIGENCE BASED LINE FOLLOWING ROBOTS
3	Theme :	DEMONSTRATION ON MODEL OF LATEST TECHNOLOGY RELEVANT ROBOT AND AI
4	Sponsored by:	DEPARTMENT OF SCIENCE & TECHNOLOGY GOVERNMENT OF INDIA
5	School Name:	mpps Gattuguda
6	Address School :	mpps Gattugud Mdl: Koutala Dist: Komurambheem mdl Koutala 504299
7	Signature of School principal with stamp	HEAD MASTER M.P.S. GATTUGUDA Mdl: Koutala Dist. Komurambheem A.P.
8	Mobile Number :	9676890710
9	Date of Program:	07-08-2019
10	Number of Student Participated	30
11	Model is Registered in School Science Book	Yes
12	Feed back of the School Science Teacher /Students	Good/Excellent
13	Signature of Project Trainer	MS
14	Signature of Project Investigator	Beel

CHAIRMAN
 M.M. Convener
 School Management Committee
 M.P.S. Koutala, M. Koutala

p-68

S.No.	Description	Details
1	Organization Name:	MULTIPURPOSE AWARENESS SOCIETY
2	Project Name:	ARTIFICIAL INTELLIGENCE BASED LINE FOLLOWING ROBOTS
3	Theme :	DEMONSTRATION ON MODEL OF LATEST TECHNOLOGY RELEVANT ROBOT AND AI
4	Sponsored by:	DEPARTMENT OF SCIENCE & TECHNOLOGY GOVERNMENT OF INDIA
5	School Name:	Bala Bharathi High School
6	Address School :	ward no-11. Near SBI Bank Kaghalnagar
7	Signature of School principal with stamp	T. Sullala Head Mistress Bala Bharathi High School Sirpur-Kaghalnagar
8	Mobile Number :	9492694788
9	Date of Program:	8.8.2019
10	Number of Student Participated	25
11	Model is Registered in School Science Book	
12	Feed back of the School Science Teacher /Students	Good/Excellent
13	Signature of Project Trainer	Kh. Kh. Kh.
14	Signature of Project Investigator	Beel



ARTIFICIAL INTELLIGENCE BASED LINE FOLLOWER ROBOT FOR RURAL SCHOOL STUDENTS IN KOMARAM BHEEM ASIFABAD DISTRICT, TELANGANA STATE
PROJECT DEMONSTRATION AND SCHOOL EXPERIMENT ACTIVITIES

P-19

SCHOOL AWARENESS PROGRAMS REGISTRATION FOAM

S.No.	Description	Details
1	Organization Name:	MULTIPURPOSE AWARENESS SOCIETY
2	Project Name:	ARTIFICIAL INTELLIGENCE BASED LINE FOLLOWING ROBOTS
3	Theme :	DEMONSTRATION ON MODEL OF LATEST TECHNOLOGY RELEVANT ROBOT AND AI
4	Sponsored by:	DEPARTMENT OF SCIENCE & TECHNOLOGY GOVERNMENT OF INDIA
5	School Name:	Z P S S Bays
6	Address School :	Sir Srik, Kagaz nagar
7	Signature of School principal with stamp	 Headmaster, G.P. II (Ganz) ZPS (B) Sirilli, Kagaznagar, Dist. K.B. Asifabad-504296
8	Mobile Number :	8074421641
9	Date of Program:	08-08-2019
10	Number of Student Participated	91
11	Model is Registered in School Science Book	YES
12	Feed back of the School Science Teacher /Students	Good/Excellent
13	Signature of Project Trainer	Khagaznagar
14	Signature of Project Investigator	Billy

P-20

SCHOOL AWARENESS PROGRAMS REGISTRATION FOAM

S.No.	Description	Details
1	Organization Name:	MULTIPURPOSE AWARENESS SOCIETY
2	Project Name:	ARTIFICIAL INTELLIGENCE BASED LINE FOLLOWING ROBOTS
3	Theme :	DEMONSTRATION ON MODEL OF LATEST TECHNOLOGY RELEVANT ROBOT AND AI
4	Sponsored by:	DEPARTMENT OF SCIENCE & TECHNOLOGY GOVERNMENT OF INDIA
5	School Name:	MPPS SADHASHIVPET
6	Address School :	vill : Sadhashivpet. Mdl : Koutala Dist : Komurambheem (Asif)
7	Signature of School principal with stamp	 HEAD MASTER MPPS SADHASHIVPET Dist. Komurambheem (Asif)
8	Mobile Number :	8897333670
9	Date of Program:	08-08-2019
10	Number of Student Participated	73
11	Model is Registered in School Science Book	Yes
12	Feed back of the School Science Teacher /Students	Good/Excellent
13	Signature of Project Trainer	Asif
14	Signature of Project Investigator	Billy

Certificates

P-71

SCHOOL AWARENESS PROGRAMS REGISTRATION FOAM

S.No.	Description	Details
1	Organization Name:	MULTIPURPOSE AWARENESS SOCIETY
2	Project Name:	ARTIFICIAL INTELLIGENCE BASED LINE FOLLOWING ROBOTS
3	Theme :	DEMONSTRATION ON MODEL OF LATEST TECHNOLOGY RELEVANT ROBOT AND AI
4	Sponsored by:	DEPARTMENT OF SCIENCE & TECHNOLOGY GOVERNMENT OF INDIA
5	School Name:	KGBV
6	Address School :	new Petrol bank, Sirpur - T
7	Signature of School principal with stamp	 SPECIAL OFFICER K.G.B.V. SIRPUR-T Dist. Komurambheem Asifabad
8	Mobile Number :	8291511655
9	Date of Program:	08-08-19
10	Number of Student Participated	70
11	Model is Registered in School Science Book	Yes
12	Feed back of the School Science Teacher /Students	Good/Excellent
13	Signature of Project Trainer	Khagaznagar
14	Signature of Project Investigator	Billy

KgbvSirpur@gmail.com

P-72

SCHOOL AWARENESS PROGRAMS REGISTRATION FOAM

S.No.	Description	Details
1	Organization Name:	MULTIPURPOSE AWARENESS SOCIETY
2	Project Name:	ARTIFICIAL INTELLIGENCE BASED LINE FOLLOWING ROBOTS
3	Theme :	DEMONSTRATION ON MODEL OF LATEST TECHNOLOGY RELEVANT ROBOT AND AI
4	Sponsored by:	DEPARTMENT OF SCIENCE & TECHNOLOGY GOVERNMENT OF INDIA
5	School Name:	MPPS Kaniki mdl : Koutala
6	Address School :	Mpps Kaniki mdl : Koutala Dist : Komurambheem 504299
7	Signature of School principal with stamp	 Head Master MPPS Kaniki Dist. Komurambheem
8	Mobile Number :	8925632999
9	Date of Program:	08-08-2019
10	Number of Student Participated	35
11	Model is Registered in School Science Book	Yes
12	Feed back of the School Science Teacher /Students	Good/Excellent
13	Signature of Project Trainer	Asif
14	Signature of Project Investigator	Billy



**ARTIFICIAL INTELLIGENCE BASED LINE FOLLOWER ROBOT
FOR RURAL SCHOOL STUDENTS IN KOMARAM BHEEM ASIFABAD
DISTRICT, TELANGANA STATE
PROJECT DEMONSTRATION AND SCHOOL EXPERIMENT ACTIVITIES**

p-23

S.No.	Description	Details
1	Organization Name:	MULTIPURPOSE AWARENESS SOCIETY
2	Project Name:	ARTIFICIAL INTELLIGENCE BASED LINE FOLLOWING ROBOTS
3	Theme :	DEMONSTRATION ON MODEL OF LATEST TECHNOLOGY RELEVANT ROBOT AND AI
4	Sponsored by:	DEPARTMENT OF SCIENCE & TECHNOLOGY GOVERNMENT OF INDIA
5	School Name:	MPUPS Gupalapetram MB
6	Address School :	MPUPS Gupalapetram. Vg- Gupalapetram (M) Kumpur (T) Komurambheem (ASF)
7	Signature of school principal with stamp	
8	Mobile Number :	92 32 795 905
9	Date of Program:	07-08-2019
10	Number of Student Participated	80
11	Model is Registered in School Science Book	Yes
12	Feed back of the School Science Teacher /Students	Good/Excellent
13	Signature of Project Trainer	
14	Signature of Project Investigator	

p-24

S.No.	Description	Details
1	Organization Name:	MULTIPURPOSE AWARENESS SOCIETY
2	Project Name:	ARTIFICIAL INTELLIGENCE BASED LINE FOLLOWING ROBOTS
3	Theme :	DEMONSTRATION ON MODEL OF LATEST TECHNOLOGY RELEVANT ROBOT AND AI
4	Sponsored by:	DEPARTMENT OF SCIENCE & TECHNOLOGY GOVERNMENT OF INDIA
5	School Name:	MPPS THUMDI
6	Address School :	Vill: Thundi hetti Mdl: Koutala Dist: Komurambheem (ASF)
7	Signature of school principal with stamp	
8	Mobile Number :	995963810
9	Date of Program:	08-08-2019
10	Number of Student Participated	73
11	Model is Registered in School Science Book	Yes
12	Feed back of the School Science Teacher /Students	Good/Excellent
13	Signature of Project Trainer	
14	Signature of Project Investigator	

Certificates

p-25

S.No.	Description	Details
1	Organization Name:	MULTIPURPOSE AWARENESS SOCIETY
2	Project Name:	ARTIFICIAL INTELLIGENCE BASED LINE FOLLOWING ROBOTS
3	Theme :	DEMONSTRATION ON MODEL OF LATEST TECHNOLOGY RELEVANT ROBOT AND AI
4	Sponsored by:	DEPARTMENT OF SCIENCE & TECHNOLOGY GOVERNMENT OF INDIA
5	School Name:	Mpps Kogugudem G
6	Address School :	Vg:- Kogugudem Mrs-Koubaala Dist:- Komurambheem (ASF)
7	Signature of School principal with stamp	
8	Mobile Number :	810 6334 197
9	Date of Program:	08-08-2017
10	Number of Student Participated	40
11	Model is Registered in School Science Book	Yes
12	Feed back of the School Science Teacher /Students	Good/Excellent
13	Signature of Project Trainer	
14	Signature of Project Investigator	

p-26

S.No.	Description	Details
1	Organization Name:	MULTIPURPOSE AWARENESS SOCIETY
2	Project Name:	ARTIFICIAL INTELLIGENCE BASED LINE FOLLOWING ROBOTS
3	Theme :	DEMONSTRATION ON MODEL OF LATEST TECHNOLOGY RELEVANT ROBOT AND AI
4	Sponsored by:	DEPARTMENT OF SCIENCE & TECHNOLOGY GOVERNMENT OF INDIA
5	School Name:	MPUPS KOUTI
6	Address School :	Vill: Koutala Mdl: Koutala Dist: Komurambheem (ASF)
7	Signature of school principal with stamp	
8	Mobile Number :	980 3956 197
9	Date of Program:	08-08-2019
10	Number of Student Participated	62
11	Model is Registered in School Science Book	Yes
12	Feed back of the School Science Teacher /Students	Good/Excellent
13	Signature of Project Trainer	
14	Signature of Project Investigator	





ARTIFICIAL INTELLIGENCE BASED LINE FOLLOWER ROBOT FOR RURAL SCHOOL STUDENTS IN KOMARAM BHEEM ASIFABAD DISTRICT, TELANGANA STATE
PROJECT DEMONSTRATION AND SCHOOL EXPERIMENT ACTIVITIES PHOTOS

Certificates



P-17

SCHOOL AWARENESS PROGRAMS REGISTRATION FOAM

S.No.	Description	Details
1	Organization Name:	MULTIPURPOSE AWARENESS SOCIETY
2	Project Name:	ARTIFICIAL INTELLIGENCE BASED LINE FOLLOWING ROBOTS
3	Theme :	DEMONSTRATION ON MODEL OF LATEST TECHNOLOGY RELEVANT ROBOT AND AI
4	Sponsored by:	DEPARTMENT OF SCIENCE & TECHNOLOGY GOVERNMENT OF INDIA
5	School Name:	TWPS PATELGUDA (VIRDHANDI) KOWTALA (ASIFABAD)
6	Address School :	TWps patelguda (Virdhandi) Kowtala (Komurambheem ASF)
7	Signature of School principal with stamp	
8	Mobile Number :	8919736891
9	Date of Program:	08-08-2019
10	Number of Student Participated	130
11	Model is Registered in School Science Book	Yes
12	Feed back of the School Science Teacher /Students	Good/Excellent
13	Signature of Project Trainer	
14	Signature of Project Investigator	

P-18

SCHOOL AWARENESS PROGRAMS REGISTRATION FOAM

S.No.	Description	Details
1	Organization Name:	MULTIPURPOSE AWARENESS SOCIETY
2	Project Name:	ARTIFICIAL INTELLIGENCE BASED LINE FOLLOWING ROBOTS
3	Theme :	DEMONSTRATION ON MODEL OF LATEST TECHNOLOGY RELEVANT ROBOT AND AI
4	Sponsored by:	DEPARTMENT OF SCIENCE & TECHNOLOGY GOVERNMENT OF INDIA
5	School Name:	TWps DHANURHETTI
6	Address School :	TWps Dhanurhetti (vi) Talodi M) Kowtala di Komurambheem (ASF)
7	Signature of School principal with stamp	
8	Mobile Number :	7801924890
9	Date of Program:	08-08-2019
10	Number of Student Participated	70
11	Model is Registered in School Science Book	Yes
12	Feed back of the School Science Teacher /Students	Good/Excellent
13	Signature of Project Trainer	
14	Signature of Project Investigator	





ARTIFICIAL INTELLIGENCE BASED LINE FOLLOWER ROBOT FOR RURAL SCHOOL STUDENTS IN KOMARAM BHEEM ASIFABAD DISTRICT, TELANGANA STATE
PROJECT DEMONSTRATION AND SCHOOL EXPERIMENT ACTIVITIES PHOTOS

Certificates

P-17

S.No.	Description	Details
1	Organization Name:	MULTIPURPOSE AWARENESS SOCIETY
2	Project Name:	ARTIFICIAL INTELLIGENCE BASED LINE FOLLOWING ROBOTS
3	Theme :	DEMONSTRATION ON MODEL OF LATEST TECHNOLOGY RELEVANT ROBOT AND AI
4	Sponsored by:	DEPARTMENT OF SCIENCE & TECHNOLOGY GOVERNMENT OF INDIA
5	School Name:	TWPS PATELGUDA (VIRDHANDI) KOWTALA (ASIFABAD)
6	Address School :	TWps patelguda (Virdhandi) Kowtala (Komurambheem ASF)
7	Signature of School principal with stamp	
8	Mobile Number :	8919736891
9	Date of Program:	08-08-2019
10	Number of Student Participated	130
11	Model is Registered in School Science Book	Yes
12	Feed back of the School Science Teacher /Students	Good/Excellent
13	Signature of Project Trainer	
14	Signature of Project Investigator	

P-18

S.No.	Description	Details
1	Organization Name:	MULTIPURPOSE AWARENESS SOCIETY
2	Project Name:	ARTIFICIAL INTELLIGENCE BASED LINE FOLLOWING ROBOTS
3	Theme :	DEMONSTRATION ON MODEL OF LATEST TECHNOLOGY RELEVANT ROBOT AND AI
4	Sponsored by:	DEPARTMENT OF SCIENCE & TECHNOLOGY GOVERNMENT OF INDIA
5	School Name:	TWps DHANURHETTI
6	Address School :	TWps Dhanurhetti (vi) Talodi M) Kowtala di Komurambheem (ASF)
7	Signature of School principal with stamp	
8	Mobile Number :	7801924890
9	Date of Program:	08-08-2019
10	Number of Student Participated	70
11	Model is Registered in School Science Book	Yes
12	Feed back of the School Science Teacher /Students	Good/Excellent
13	Signature of Project Trainer	
14	Signature of Project Investigator	

School Awareness Programs Photos





ARTIFICIAL INTELLIGENCE BASED LINE FOLLOWER ROBOT FOR RURAL SCHOOL STUDENTS IN KOMARAM BHEEM ASIFABAD DISTRICT, TELANGANA STATE
PROJECT DEMONSTRATION AND SCHOOL EXPERIMENT ACTIVITIES

P-49

S.No.	Description	Details
1	Organization Name	M.P.P.S. IPPALAGUDA
2	Project Name	ARTIFICIAL INTELLIGENCE BASED LINE FOLLOWING ROBOTS
3	Theme	DEMONSTRATION ON MODEL OF LATEST TECHNOLOGY RELEVANT ROBOT AND AI
4	Sponsored by	DEPARTMENT OF SCIENCE & TECHNOLOGY GOVERNMENT OF INDIA
5	School Name	MPPS IPPALAGUDA
6	Address School	Vill. Bodkampally, Md. Koutala, Dist. Komurambhoom (ASF).
7	Signature of School principal with stamp	I.C.S. Lawla, HEAD MASTER, MPPS IPPALAGUDA, Dist. Komurambhoom, Telangana.
8	Mobile Number	7613986197
9	Date of Program	05-06-2019
10	Number of Student Participated	29
11	Model is Registered in School Science Book	Yes
12	Free back of the School Science Book	Good student
13	Signature of Project Investigator	MSJ Beel

I.C.S. Lawla
HEAD MASTER
MPPS IPPALAGUDA
Mandal Koutala
Dist. Komurambhoom Asifabad

P-50

S.No.	Description	Details
1	Organization Name	M.P.P.S. SHIVALINGAPUR
2	Project Name	ARTIFICIAL INTELLIGENCE BASED LINE FOLLOWING ROBOTS
3	Theme	DEMONSTRATION ON MODEL OF LATEST TECHNOLOGY RELEVANT ROBOT AND AI
4	Sponsored by	DEPARTMENT OF SCIENCE & TECHNOLOGY GOVERNMENT OF INDIA
5	School Name	Govt. Twp. Shivalingapur
6	Address School	Shivalingapur Md. Koutala Dist. Komurambhoom, Asf
7	Signature of School principal with stamp	Chairman Convener, School Management Committee, Govt. Twp. Primary School Shivalingapur, Md. Koutala, Dist. Komurambhoom, Asf.
8	Mobile Number	9553017629
9	Date of Program	05-08-2019
10	Number of Student Participated	111
11	Model is Registered in School Science Book	Yes
12	Free back of the School Science Book	Good student
13	Signature of Project Investigator	MSJ Beel

Certificates

P-51

S.No.	Description	Details
1	Organization Name	M.P.P.S. GUNDAIPET
2	Project Name	ARTIFICIAL INTELLIGENCE BASED LINE FOLLOWING ROBOTS
3	Theme	DEMONSTRATION ON MODEL OF LATEST TECHNOLOGY RELEVANT ROBOT AND AI
4	Sponsored by	DEPARTMENT OF SCIENCE & TECHNOLOGY GOVERNMENT OF INDIA
5	School Name	MPPS Gundaipet
6	Address School	Vill. Gundaipet md. Koutala Dist. Komurambhoom (ASF)
7	Signature of School principal with stamp	I.C. Beel, HEAD MASTER, MPPS GUNDAIPET, Dist. Komurambhoom, Telangana.
8	Mobile Number	9177273784
9	Date of Program	05/08/2019
10	Number of Student Participated	140
11	Model is Registered in School Science Book	Yes
12	Free back of the School Science Book	Good student
13	Signature of Project Investigator	MSJ Beel

Head Master
P. P. S. GUNDAIPET
M.P. KOUTALA

P-52

S.No.	Description	Details
1	Organization Name	M.P.P.S. KANNEPALLI
2	Project Name	ARTIFICIAL INTELLIGENCE BASED LINE FOLLOWING ROBOTS
3	Theme	DEMONSTRATION ON MODEL OF LATEST TECHNOLOGY RELEVANT ROBOT AND AI
4	Sponsored by	DEPARTMENT OF SCIENCE & TECHNOLOGY GOVERNMENT OF INDIA
5	School Name	MPPS Kannepalli
6	Address School	M. Koutala, Kannepalli
7	Signature of School principal with stamp	Chairman, HEAD MASTER, M.P.P.S. KANNEPALLI, Dist. Komurambhoom, Telangana.
8	Mobile Number	9963114317 / 8919345258
9	Date of Program	6-Aug-19
10	Number of Student Participated	42
11	Model is Registered in School Science Book	Yes
12	Free back of the School Science Book	Good student
13	Signature of Project Investigator	MSJ Beel



ARTIFICIAL INTELLIGENCE BASED LINE FOLLOWER ROBOT FOR RURAL SCHOOL STUDENTS IN KOMARAM BHEEM ASIFABAD DISTRICT, TELANGANA STATE
PROJECT DEMONSTRATION AND SCHOOL EXPERIMENT ACTIVITIES

P-53

S.No.	Description	Details
1	Organization Name:	MULTIPURPOSE AWARENESS SOCIETY
2	Project Name:	ARTIFICIAL INTELLIGENCE BASED LINE FOLLOWING ROBOTS
3	Theme:	DEMONSTRATION ON MODEL OF LATEST TECHNOLOGY RELEVANT ROBOT AND AI
4	Sponsored by:	DEPARTMENT OF SCIENCE & TECHNOLOGY GOVERNMENT OF INDIA
5	School Name:	MP UPS: Gudlaboni
6	Address School:	Gudlaboni Mdl: Koutala Dist: Kumyambheem
7	Signature of School principal with stamp:	IC HEAD MASTER MP UPS Gudlaboni Mdl: Koutala, Dist: Kumyambheem
8	Mobile Number:	8999261009
9	Date of Program:	6/8/2019
10	Number of Student Participated:	35/54
11	Model is Registered in School Science Book:	Yes
12	Feed back of the School Science Teacher /Students:	Good/Excellent
13	Signature of Project Trainer:	M/S
14	Signature of Project Investigator:	Billy

P-54

S.No.	Description	Details
1	Organization Name:	MULTIPURPOSE AWARENESS SOCIETY
2	Project Name:	ARTIFICIAL INTELLIGENCE BASED LINE FOLLOWING ROBOTS
3	Theme:	DEMONSTRATION ON MODEL OF LATEST TECHNOLOGY RELEVANT ROBOT AND AI
4	Sponsored by:	DEPARTMENT OF SCIENCE & TECHNOLOGY GOVERNMENT OF INDIA
5	School Name:	Govt. AHS Mogad Dhagad
6	Address School:	Vill: Mogad Dhagad, Mand: Koutala, Dist: K.B. Asifabad.
7	Signature of School principal with stamp:	M/S
8	Mobile Number:	180
9	Date of Program:	06-08-2019
10	Number of Student Participated:	180
11	Model is Registered in School Science Book:	Yes
12	Feed back of the School Science Teacher /Students:	Good/Excellent
13	Signature of Project Trainer:	M/S
14	Signature of Project Investigator:	Billy

Certificates

P-55

S.No.	Description	Details
1	Organization Name:	MULTIPURPOSE AWARENESS SOCIETY
2	Project Name:	ARTIFICIAL INTELLIGENCE BASED LINE FOLLOWING ROBOTS
3	Theme:	DEMONSTRATION ON MODEL OF LATEST TECHNOLOGY RELEVANT ROBOT AND AI
4	Sponsored by:	DEPARTMENT OF SCIENCE & TECHNOLOGY GOVERNMENT OF INDIA
5	School Name:	Z.P.S.S LONAVELLY, SIRPUR(T)
6	Address School:	Vill: LONAVELLY, Mdl: SIRPUR(T) Dist: KOMARAM BHEEM ASIFABAD 514299.
7	Signature of School principal with stamp:	HEAD MASTER Z.P.S.S. Lonavelly Mdl. Sirpur-T Dist: Kumyambheem Asf.
8	Mobile Number:	9705773516
9	Date of Program:	6/08/2019
10	Number of Student Participated:	35
11	Model is Registered in School Science Book:	Yes
12	Feed back of the School Science Teacher /Students:	Good/Excellent
13	Signature of Project Trainer:	M/S
14	Signature of Project Investigator:	Billy

P-56

S.No.	Description	Details
1	Organization Name:	MULTIPURPOSE AWARENESS SOCIETY
2	Project Name:	ARTIFICIAL INTELLIGENCE BASED LINE FOLLOWING ROBOTS
3	Theme:	DEMONSTRATION ON MODEL OF LATEST TECHNOLOGY RELEVANT ROBOT AND AI
4	Sponsored by:	DEPARTMENT OF SCIENCE & TECHNOLOGY GOVERNMENT OF INDIA
5	School Name:	T.W.P.S K-B Colony Mogaddhagad.
6	Address School:	village: Mogaddhagad. man: Koutala Dist: Kumyambheem Asifabad.
7	Signature of School principal with stamp:	HEAD MASTER T.W.P.S. K-B Colony, Dist: K.B. Asifabad.
8	Mobile Number:	9441101226
9	Date of Program:	06-08-2019
10	Number of Student Participated:	122
11	Model is Registered in School Science Book:	Yes
12	Feed back of the School Science Teacher /Students:	Good/Excellent
13	Signature of Project Trainer:	M/S
14	Signature of Project Investigator:	Billy



**ARTIFICIAL INTELLIGENCE BASED LINE FOLLOWER ROBOT
FOR RURAL SCHOOL STUDENTS IN KOMARAM BHEEM ASIFABAD
DISTRICT, TELANGANA STATE
PROJECT DEMONSTRATION AND SCHOOL EXPERIMENT ACTIVITIES**

P-58

SCHOOL AWARENESS PROGRAMS REGISTRATION FOAM

S.No.	Description	Details
1	Organization Name:	MULTIPURPOSE AWARENESS SOCIETY
2	Project Name:	ARTIFICIAL INTELLIGENCE BASED LINE FOLLOWING ROBOTS
3	Theme :	DEMONSTRATION ON MODEL OF LATEST TECHNOLOGY RELEVANT ROBOT AND AI
4	Sponsored by:	DEPARTMENT OF SCIENCE & TECHNOLOGY GOVERNMENT OF INDIA
5	School Name:	TSWRES Kagaznagar (gnb) Sirpur (r)
6	Address School :	Vill: Sirpur (r) Md: Sirpur (r) Dist: Komurambheem Asifabad 504299
7	Signature of School principal with stamp	 PRINCIPAL TS W Res. SCHOOL KAGHAZNAGAR
8	Mobile Number :	7995010573
9	Date of Program:	6/08/2019
10	Number of Student Participated	50
11	Model is Registered in School Science Book	Yes
12	Feed back of the School Science Teacher /Students	Good/Excellent
13	Signature of Project Trainer	
14	Signature of Project Investigator	

P-59

SCHOOL AWARENESS PROGRAMS REGISTRATION FOAM

S.No.	Description	Details
1	Organization Name:	MULTIPURPOSE AWARENESS SOCIETY
2	Project Name:	ARTIFICIAL INTELLIGENCE BASED LINE FOLLOWING ROBOTS
3	Theme :	DEMONSTRATION ON MODEL OF LATEST TECHNOLOGY RELEVANT ROBOT AND AI
4	Sponsored by:	DEPARTMENT OF SCIENCE & TECHNOLOGY GOVERNMENT OF INDIA
5	School Name:	MPPS PARDI
6	Address School :	Vill: Pardi, Md: Koutala Dist: Komurambheem (Asf)
7	Signature of school principal with stamp	 HEAD MASTER MPPS PARDI MPPS PARDI
8	Mobile Number :	9808613250
9	Date of Program:	07-08-2019
10	Number of Student Participated	48
11	Model is Registered in School Science Book	Yes
12	Feed back of the School Science Teacher /Students	Good/Excellent
13	Signature of Project Trainer	
14	Signature of Project Investigator	

Certificates

P-59

SCHOOL AWARENESS PROGRAMS REGISTRATION FOAM

School code - 36021101003

S.No.	Description	Details
1	Organization Name:	MULTIPURPOSE AWARENESS SOCIETY
2	Project Name:	ARTIFICIAL INTELLIGENCE BASED LINE FOLLOWING ROBOTS
3	Theme :	DEMONSTRATION ON MODEL OF LATEST TECHNOLOGY RELEVANT ROBOT AND AI
4	Sponsored by:	DEPARTMENT OF SCIENCE & TECHNOLOGY GOVERNMENT OF INDIA
5	School Name:	mpups mogad dagad
6	Address School :	mpups mogad dagad md: Koutala, Dist: Komurambheem
7	Signature of School principal with stamp	 HEAD MASTER MPUPS, MOGAD DHAGAD MP: Koutala, Dist: ADE.
8	Mobile Number :	9676890710
9	Date of Program:	07/08/2019
10	Number of Student Participated	145
11	Model is Registered in School Science Book	Yes
12	Feed back of the School Science Teacher /Students	Good/Excellent
13	Signature of Project Trainer	
14	Signature of Project Investigator	

P-60

SCHOOL AWARENESS PROGRAMS REGISTRATION FOAM

S.No.	Description	Details
1	Organization Name:	MULTIPURPOSE AWARENESS SOCIETY
2	Project Name:	ARTIFICIAL INTELLIGENCE BASED LINE FOLLOWING ROBOTS
3	Theme :	DEMONSTRATION ON MODEL OF LATEST TECHNOLOGY RELEVANT ROBOT AND AI
4	Sponsored by:	DEPARTMENT OF SCIENCE & TECHNOLOGY GOVERNMENT OF INDIA
5	School Name:	Mpps. shirsha
6	Address School :	v: Shirsha, Md: Koutala, Dist: Komurambheem (Asf)
7	Signature of School principal with stamp	 HEAD MASTER MPPS SHIRSHA
8	Mobile Number :	9642903609
9	Date of Program:	07-08-2019
10	Number of Student Participated	50
11	Model is Registered in School Science Book	Yes
12	Feed back of the School Science Teacher /Students	Good/Excellent
13	Signature of Project Trainer	
14	Signature of Project Investigator	



ARTIFICIAL INTELLIGENCE BASED LINE FOLLOWER ROBOT FOR RURAL SCHOOL STUDENTS IN KOMARAM BHEEM ASIFABAD DISTRICT, TELANGANA STATE PROJECT DEMONSTRATION AND SCHOOL EXPERIMENT ACTIVITIES

p-61

S.No.	Description	Details
1	Organization Name:	MULTIPURPOSE AWARENESS SOCIETY
2	Project Name:	ARTIFICIAL INTELLIGENCE BASED LINE FOLLOWING ROBOTS
3	Theme :	DEMONSTRATION ON MODEL OF LATEST TECHNOLOGY RELEVANT ROBOT AND AI
4	Sponsored by:	DEPARTMENT OF SCIENCE & TECHNOLOGY GOVERNMENT OF INDIA
5	School Name:	MPPS VIRDHADI
6	Address School :	Vill: Viradhadi Mdl: Koutala Dist: Komurambheem (ASE)
7	Signature of school principal with stamp	HEAD MASTER MPPS Patha Kannepally Mandir: Koutala Dist: Komurambheem
8	Mobile Number :	9015324921
9	Date of Program:	07-08-2019
10	Number of Student Participated	69
11	Model is Registered in School Science Book	Yes
12	Feed back of the School Science Teacher /Students	Good/Excellent
13	Signature of Project Trainer	M/S
14	Signature of Project Investigator	Beel

p-62

S.No.	Description	Details
1	Organization Name:	MULTIPURPOSE AWARENESS SOCIETY
2	Project Name:	ARTIFICIAL INTELLIGENCE BASED LINE FOLLOWING ROBOTS
3	Theme :	DEMONSTRATION ON MODEL OF LATEST TECHNOLOGY RELEVANT ROBOT AND AI
4	Sponsored by:	DEPARTMENT OF SCIENCE & TECHNOLOGY GOVERNMENT OF INDIA
5	School Name:	MPPS. SIDHAPUR.
6	Address School :	Vill: Sidhapur Mdl: Koutala Komurambheem (ASE)
7	Signature of school principal with stamp	HEAD MASTER MPPS Sidhapur Mandir: Koutala Dist: Komurambheem
8	Mobile Number :	9929865909
9	Date of Program:	07-08-2019
10	Number of Student Participated	53
11	Model is Registered in School Science Book	Yes
12	Feed back of the School Science Teacher /Students	Good/Excellent
13	Signature of Project Trainer	M/S
14	Signature of Project Investigator	Beel

Certificates

p-63

S.No.	Description	Details
1	Organization Name:	MULTIPURPOSE AWARENESS SOCIETY
2	Project Name:	ARTIFICIAL INTELLIGENCE BASED LINE FOLLOWING ROBOTS
3	Theme :	DEMONSTRATION ON MODEL OF LATEST TECHNOLOGY RELEVANT ROBOT AND AI
4	Sponsored by:	DEPARTMENT OF SCIENCE & TECHNOLOGY GOVERNMENT OF INDIA
5	School Name:	mpps pathakannepally mdl Koutala
6	Address School :	mpps patha kannepally mdl Koutala Dist Komurambheem
7	Signature of school principal with stamp	HEAD MASTER MPPS Patha Kannepally Mandir: Koutala Dist: Komurambheem
8	Mobile Number :	8985632399
9	Date of Program:	07-08-2019
10	Number of Student Participated	109
11	Model is Registered in School Science Book	Yes
12	Feed back of the School Science Teacher /Students	Good/Excellent
13	Signature of Project Trainer	M/S
14	Signature of Project Investigator	Beel

p-64

S.No.	Description	Details
1	Organization Name:	MULTIPURPOSE AWARENESS SOCIETY
2	Project Name:	ARTIFICIAL INTELLIGENCE BASED LINE FOLLOWING ROBOTS
3	Theme :	DEMONSTRATION ON MODEL OF LATEST TECHNOLOGY RELEVANT ROBOT AND AI
4	Sponsored by:	DEPARTMENT OF SCIENCE & TECHNOLOGY GOVERNMENT OF INDIA
5	School Name:	mpps Kumbhari mdl Koutala
6	Address School :	mpps Kumbhari mdl Koutala Dist. Komurambheem
7	Signature of school principal with stamp	HEAD MASTER MPPS, KUMBHARI Mandir: Koutala Dist: Komurambheem
8	Mobile Number :	9676890710
9	Date of Program:	07-08-2019
10	Number of Student Participated	119
11	Model is Registered in School Science Book	Yes
12	Feed back of the School Science Teacher /Students	Good/Excellent
13	Signature of Project Trainer	M/S
14	Signature of Project Investigator	Beel



**ARTIFICIAL INTELLIGENCE BASED LINE FOLLOWER ROBOT
FOR RURAL SCHOOL STUDENTS IN KOMARAM BHEEM ASIFABAD
DISTRICT, TELANGANA STATE
PROJECT DEMONSTRATION AND SCHOOL EXPERIMENT ACTIVITIES**

p-65

S.No.	Description	Details
1	Organization Name:	MULTIPURPOSE AWARENESS SOCIETY
2	Project Name:	ARTIFICIAL INTELLIGENCE BASED LINE FOLLOWING ROBOTS
3	Theme :	DEMONSTRATION ON MODEL OF LATEST TECHNOLOGY RELEVANT ROBOT AND AI
4	Sponsored by:	DEPARTMENT OF SCIENCE & TECHNOLOGY GOVERNMENT OF INDIA
5	School Name:	mpps Bheeravathi mdt Koutala
6	Address School :	mpps Bheeravathi mdt Koutala Dist: Komurambheem
7	Signature of School principal with stamp	HEAD MASTER M.P.S. Bheeravathi mdt Koutala Dist: Komurambheem
8	Mobile Number :	8985632399
9	Date of Program:	07-08-2019
10	Number of Student Participated	114
11	Model is Registered in School Science Book	Yes
12	Feed back of the School Science Teacher /Students	Good/Excellent
13	Signature of Project Trainer	MS
14	Signature of Project Investigator	Bell

p-66

S.No.	Description	Details
1	Organization Name:	MULTIPURPOSE AWARENESS SOCIETY
2	Project Name:	ARTIFICIAL INTELLIGENCE BASED LINE FOLLOWING ROBOTS
3	Theme :	DEMONSTRATION ON MODEL OF LATEST TECHNOLOGY RELEVANT ROBOT AND AI
4	Sponsored by:	DEPARTMENT OF SCIENCE & TECHNOLOGY GOVERNMENT OF INDIA
5	School Name:	mpps Vajram mdt Koutala
6	Address School :	mpps Vajram mdt Koutala Dist: Komurambheem 504249
7	Signature of School principal with stamp	HEAD MASTER M.P.S. Vajram mdt Koutala Dist: Komurambheem
8	Mobile Number :	8985632399
9	Date of Program:	07-08-2019
10	Number of Student Participated	104
11	Model is Registered in School Science Book	Yes
12	Feed back of the School Science Teacher /Students	Good/Excellent
13	Signature of Project Trainer	MS
14	Signature of Project Investigator	Bell

Certificates

p-67

S.No.	Description	Details
1	Organization Name:	MULTIPURPOSE AWARENESS SOCIETY
2	Project Name:	ARTIFICIAL INTELLIGENCE BASED LINE FOLLOWING ROBOTS
3	Theme :	DEMONSTRATION ON MODEL OF LATEST TECHNOLOGY RELEVANT ROBOT AND AI
4	Sponsored by:	DEPARTMENT OF SCIENCE & TECHNOLOGY GOVERNMENT OF INDIA
5	School Name:	mpps Gattuguda
6	Address School :	mpps Gattuguda mdt Koutala Dist: Komurambheem 504299
7	Signature of School principal with stamp	HEAD MASTER M.P.S. Gattuguda mdt Koutala Dist: Komurambheem
8	Mobile Number :	9676890710
9	Date of Program:	07-08-2019
10	Number of Student Participated	30
11	Model is Registered in School Science Book	Yes
12	Feed back of the School Science Teacher /Students	Good/Excellent
13	Signature of Project Trainer	MS
14	Signature of Project Investigator	Bell

Chairman / HOD/Convener
School Management Committee
M.P.S. mdt Koutala

p-68

S.No.	Description	Details
1	Organization Name:	MULTIPURPOSE AWARENESS SOCIETY
2	Project Name:	ARTIFICIAL INTELLIGENCE BASED LINE FOLLOWING ROBOTS
3	Theme :	DEMONSTRATION ON MODEL OF LATEST TECHNOLOGY RELEVANT ROBOT AND AI
4	Sponsored by:	DEPARTMENT OF SCIENCE & TECHNOLOGY GOVERNMENT OF INDIA
5	School Name:	Bala Bharathi High School
6	Address School :	Ward No-11, Near SBI Bank Kalyan Nagar
7	Signature of School principal with stamp	T. Bindu Head Mistress Bala Bharathi High School Sirpur-Kalyan Nagar
8	Mobile Number :	9492694788
9	Date of Program:	8-8-2019
10	Number of Student Participated	25
11	Model is Registered in School Science Book	
12	Feed back of the School Science Teacher /Students	Good/Excellent
13	Signature of Project Trainer	Kalyan
14	Signature of Project Investigator	Bell



ARTIFICIAL INTELLIGENCE BASED LINE FOLLOWER ROBOT FOR RURAL SCHOOL STUDENTS IN KOMARAM BHEEM ASIFABAD DISTRICT, TELANGANA STATE
PROJECT DEMONSTRATION AND SCHOOL EXPERIMENT ACTIVITIES

P-69

S.No.	Description	Details
1	Organization Name:	MULTIPURPOSE AWARENESS SOCIETY
2	Project Name:	ARTIFICIAL INTELLIGENCE BASED LINE FOLLOWING ROBOTS
3	Theme :	DEMONSTRATION ON MODEL OF LATEST TECHNOLOGY RELEVANT ROBOT AND AI
4	Sponsored by:	DEPARTMENT OF SCIENCE & TECHNOLOGY GOVERNMENT OF INDIA
5	School Name:	Z P S S Boys
6	Address School :	Sir Srik, Kragaz nagar
7	Signature of School principal with stamp	Headmaster, G-II (Girls) ZPSS (B) Sirsrik, Kragaznagar, Dist. K.B. Asifabad-504298
8	Mobile Number :	80744-21641.
9	Date of Program:	08-08-2019.
10	Number of Student Participated	91
11	Model is Registered in School Science Book	YES
12	Feed back of the School Science Teacher /Students	Good/Excellent
13	Signature of Project Trainer	Khagabadi
14	Signature of Project Investigator	Billy

P-70

S.No.	Description	Details
1	Organization Name:	MULTIPURPOSE AWARENESS SOCIETY
2	Project Name:	ARTIFICIAL INTELLIGENCE BASED LINE FOLLOWING ROBOTS
3	Theme :	DEMONSTRATION ON MODEL OF LATEST TECHNOLOGY RELEVANT ROBOT AND AI
4	Sponsored by:	DEPARTMENT OF SCIENCE & TECHNOLOGY GOVERNMENT OF INDIA
5	School Name:	MPPS SAPHASHIPET
6	Address School :	vill : Sathashiv pet. rd : Koutala Dist : Komurambheem (AIF)
7	Signature of School principal with stamp	Head Master MPPS SAPHASHIPET
8	Mobile Number :	8897333670
9	Date of Program:	08-08-2019
10	Number of Student Participated	73
11	Model is Registered in School Science Book	Yes
12	Feed back of the School Science Teacher /Students	Good/Excellent
13	Signature of Project Trainer	MAJ
14	Signature of Project Investigator	Billy

Certificates

P-71

S.No.	Description	Details
1	Organization Name:	MULTIPURPOSE AWARENESS SOCIETY
2	Project Name:	ARTIFICIAL INTELLIGENCE BASED LINE FOLLOWING ROBOTS
3	Theme :	DEMONSTRATION ON MODEL OF LATEST TECHNOLOGY RELEVANT ROBOT AND AI
4	Sponsored by:	DEPARTMENT OF SCIENCE & TECHNOLOGY GOVERNMENT OF INDIA
5	School Name:	KGBV
6	Address School :	near petrol bunk, Sirpur - T
7	Signature of School principal with stamp	SPECIAL OFFICER K.G.B.V. SIRPUR-T Dist: Komurambheem Asifabad
8	Mobile Number :	829511655
9	Date of Program:	08-08-19
10	Number of Student Participated	70
11	Model is Registered in School Science Book	Yes
12	Feed back of the School Science Teacher /Students	Good/Excellent
13	Signature of Project Trainer	Khagabadi
14	Signature of Project Investigator	Billy

Kgbv.sirpur7@gmail.com

P-72

S.No.	Description	Details
1	Organization Name:	MULTIPURPOSE AWARENESS SOCIETY
2	Project Name:	ARTIFICIAL INTELLIGENCE BASED LINE FOLLOWING ROBOTS
3	Theme :	DEMONSTRATION ON MODEL OF LATEST TECHNOLOGY RELEVANT ROBOT AND AI
4	Sponsored by:	DEPARTMENT OF SCIENCE & TECHNOLOGY GOVERNMENT OF INDIA
5	School Name:	MPPS Kaniki mdi 1 Koutala
6	Address School :	Mpps Kaniki mdi Koutala dist. Komurambheem 504199
7	Signature of School principal with stamp	Head Master MPPS Kaniki mdi Koutala
8	Mobile Number :	8925632399
9	Date of Program:	08-08-2019
10	Number of Student Participated	35
11	Model is Registered in School Science Book	Yes
12	Feed back of the School Science Teacher /Students	Good/Excellent
13	Signature of Project Trainer	MAJ
14	Signature of Project Investigator	Billy



**ARTIFICIAL INTELLIGENCE BASED LINE FOLLOWER ROBOT
FOR RURAL SCHOOL STUDENTS IN KOMARAM BHEEM ASIFABAD
DISTRICT, TELANGANA STATE
PROJECT DEMONSTRATION AND SCHOOL EXPERIMENT ACTIVITIES**

P-33

S.No.	Description	Details
1	Organization Name:	MULTIPURPOSE AWARENESS SOCIETY
2	Project Name:	ARTIFICIAL INTELLIGENCE BASED LINE FOLLOWING ROBOTS
3	Theme :	DEMONSTRATION ON MODEL OF LATEST TECHNOLOGY RELEVANT ROBOT AND AI
4	Sponsored by:	DEPARTMENT OF SCIENCE & TECHNOLOGY GOVERNMENT OF INDIA
5	School Name:	MPUPS Gupalapatnam (M)
6	Address School :	MPUPS Gupalapatnam - vi:8 - Gupalapatnam (M) Sirpur (T) Komurambheem (ASF)
7	Signature of School principal with stamp	
8	Mobile Number :	9232795905
9	Date of Program:	07-08-2019
10	Number of Student Participated	80
11	Model is Registered in School Science Book	Yes
12	Feed back of the School Science Teacher /Students	Good/Excellent
13	Signature of Project Trainer	
14	Signature of Project Investigator	

P-34

S.No.	Description	Details
1	Organization Name:	MULTIPURPOSE AWARENESS SOCIETY
2	Project Name:	ARTIFICIAL INTELLIGENCE BASED LINE FOLLOWING ROBOTS
3	Theme :	DEMONSTRATION ON MODEL OF LATEST TECHNOLOGY RELEVANT ROBOT AND AI
4	Sponsored by:	DEPARTMENT OF SCIENCE & TECHNOLOGY GOVERNMENT OF INDIA
5	School Name:	MPPS THUMDI
6	Address School :	Vill: Thumdi hetti Mdt: Koutala Dist: Komurambheem (ASF)
7	Signature of School principal with stamp	
8	Mobile Number :	9959638110
9	Date of Program:	08-08-2019
10	Number of Student Participated	73
11	Model is Registered in School Science Book	Yes
12	Feed back of the School Science Teacher /Students	Good/Excellent
13	Signature of Project Trainer	
14	Signature of Project Investigator	

Certificates

P-35

S.No.	Description	Details
2	Project Name:	ARTIFICIAL INTELLIGENCE BASED LINE FOLLOWING ROBOTS
3	Theme :	DEMONSTRATION ON MODEL OF LATEST TECHNOLOGY RELEVANT ROBOT AND AI
4	Sponsored by:	DEPARTMENT OF SCIENCE & TECHNOLOGY GOVERNMENT OF INDIA
5	School Name:	Mpps Koyogudam G1
6	Address School :	Vi:- Koyogudam Mns-Koubarla Di:- Komurambheem (ASF)
7	Signature of School principal with stamp	
8	Mobile Number :	8106334197
9	Date of Program:	08-08-2017
11	Model is Registered in School Science Book	Yes
12	Feed back of the School Science Teacher /Students	Good/Excellent
13	Signature of Project Trainer	
14	Signature of Project Investigator	

P-36



S.No.	Description	Details
2	Project Name:	ARTIFICIAL INTELLIGENCE BASED LINE FOLLOWING ROBOTS
3	Theme :	DEMONSTRATION ON MODEL OF LATEST TECHNOLOGY RELEVANT ROBOT AND AI
4	Sponsored by:	DEPARTMENT OF SCIENCE & TECHNOLOGY GOVERNMENT OF INDIA
5	School Name:	MPUPS KOUTI
6	Address School :	Vill: Kouti Mdt: Kouti Dist: Komurambheem (ASF)
7	Signature of School principal with stamp	
8	Mobile Number :	9803956197
9	Date of Program:	08-08-2019
10	Number of Student Participated	62
11	Model is Registered in School Science Book	Yes
12	Feed back of the School Science Teacher /Students	Good/Excellent
13	Signature of Project Trainer	
14	Signature of Project Investigator	





ARTIFICIAL INTELLIGENCE BASED LINE FOLLOWER ROBOT FOR RURAL SCHOOL STUDENTS IN KOMARAM BHEEM ASIFABAD DISTRICT, TELANGANA STATE
PROJECT DEMONSTRATION AND SCHOOL EXPERIMENT ACTIVITIES PHOTOS

Certificates

P-27

S.No.	Description	Details
1	Organization Name:	MULTIPURPOSE AWARENESS SOCIETY
2	Project Name:	ARTIFICIAL INTELLIGENCE BASED LINE FOLLOWING ROBOTS
3	Theme :	DEMONSTRATION ON MODEL OF LATEST TECHNOLOGY RELEVANT ROBOT AND AI
4	Sponsored by:	DEPARTMENT OF SCIENCE & TECHNOLOGY GOVERNMENT OF INDIA
5	School Name:	TWPS PATELGUDA (VIRDHANOLI) KOWTALA (ASIFABAD)
6	Address School :	TWPS Patelguda (Viradhanoli) Kowtala (Komurambheem ASF)
7	Signature of School principal with stamp	
8	Mobile Number :	8919736891
9	Date of Program:	08-08-2019
10	Number of Student Participated	130
11	Model is Registered in School Science Book	Yes
12	Feed back of the School Science Teacher /Students	Good/Excellent
13	Signature of Project Trainer	
14	Signature of Project Investigator	

P-28

S.No.	Description	Details
1	Organization Name:	MULTIPURPOSE AWARENESS SOCIETY
2	Project Name:	ARTIFICIAL INTELLIGENCE BASED LINE FOLLOWING ROBOTS
3	Theme :	DEMONSTRATION ON MODEL OF LATEST TECHNOLOGY RELEVANT ROBOT AND AI
4	Sponsored by:	DEPARTMENT OF SCIENCE & TECHNOLOGY GOVERNMENT OF INDIA
5	School Name:	TWPS DHANURHETTI
6	Address School :	TWPS Dhanurhetti (vi) Talodi (M) Kowtala (vi) Komurambheem (ASF)
7	Signature of School principal with stamp	
8	Mobile Number :	7801924890
9	Date of Program:	08-08-2019
10	Number of Student Participated	70
11	Model is Registered in School Science Book	Yes
12	Feed back of the School Science Teacher /Students	Good/Excellent
13	Signature of Project Trainer	
14	Signature of Project Investigator	

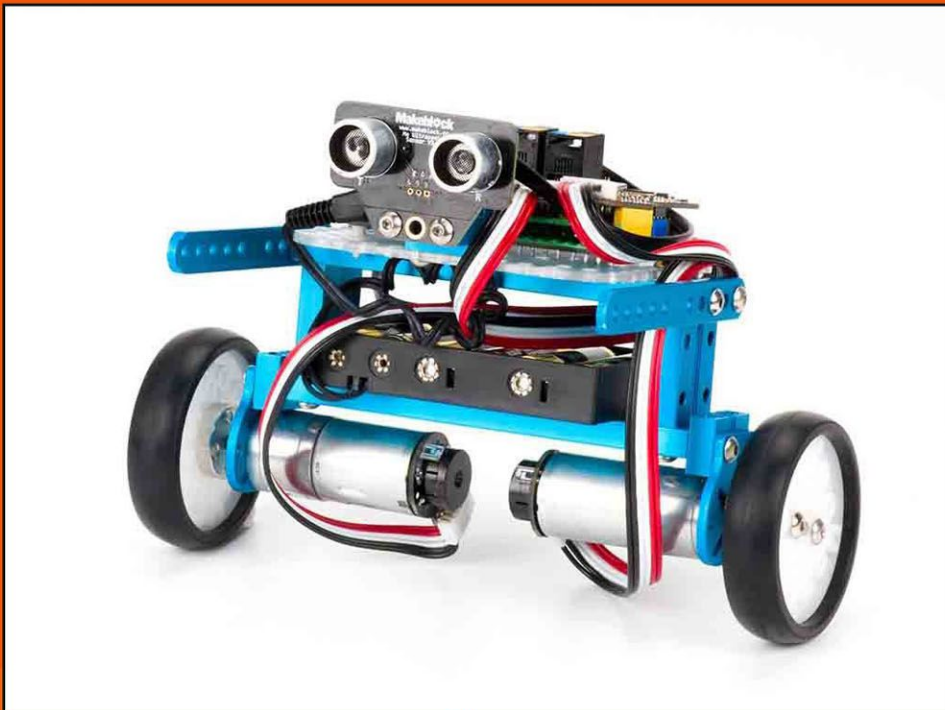



**ARTIFICIAL INTELLIGENCE BASED LINE FOLLOWER ROBOT
FOR RURAL SCHOOL STUDENTS IN KOMARAM BHEEM ASIFABAD
DISTRICT, TELANGANA STATE**
PROJECT DEMONSTRATION AND SCHOOL EXPERIMENT ACTIVITIES
Certificates

P-66

S.No.	Description	Details
1	Organization Name:	MULTIPURPOSE AWARENESS SOCIETY
2	Project Name:	ARTIFICIAL INTELLIGENCE BASED LINE FOLLOWING ROBOTS
3	Theme :	DEMONSTRATION ON MODEL OF LATEST TECHNOLOGY RELEVANT ROBOT AND AI
4	Sponsored by:	DEPARTMENT OF SCIENCE & TECHNOLOGY GOVERNMENT OF INDIA
5	School Name:	Govt. AHS (B) Sirpur -T
6	Address School :	Sirpur -T KBM- Asifabad
7	Signature of School principal with stamp	 S.P. Headmaster Govt. Ashram High School (B) Sirpur (T) Dist. Kumram Bheem Asifabad
8	Mobile Number :	9494028604
9	Date of Program:	28/08/2019
10	Number of Student Participated	38
11	Model is Registered in School Science Book	Yes
12	Feed back of the School Science Teacher /Students	Good/Excellent
13	Signature of Project Trainer	
14	Signature of Project Investigator	

P-67

S.No.	Description	Details
1	Organization Name:	MULTIPURPOSE AWARENESS SOCIETY
2	Project Name:	ARTIFICIAL INTELLIGENCE BASED LINE FOLLOWING ROBOTS
3	Theme :	DEMONSTRATION ON MODEL OF LATEST TECHNOLOGY RELEVANT ROBOT AND AI
4	Sponsored by:	DEPARTMENT OF SCIENCE & TECHNOLOGY GOVERNMENT OF INDIA
5	School Name:	MPPS - SOANPET Elm & Tm.
6	Address School :	SOANPET, SIRPUR -T
7	Signature of School principal with stamp	 Headmaster M.P.P.S. SOANPET(TM) Mdi. Sirpur-I
8	Mobile Number :	7013627930
9	Date of Program:	28-08-2019
10	Number of Student Participated	31
11	Model is Registered in School Science Book	
12	Feed back of the School Science Teacher /Students	Good/Excellent Good.
13	Signature of Project Trainer	
14	Signature of Project Investigator	

P-68

S.No.	Description	Details
1	Organization Name:	MULTIPURPOSE AWARENESS SOCIETY
2	Project Name:	ARTIFICIAL INTELLIGENCE BASED LINE FOLLOWING ROBOTS
3	Theme :	DEMONSTRATION ON MODEL OF LATEST TECHNOLOGY RELEVANT ROBOT AND AI
4	Sponsored by:	DEPARTMENT OF SCIENCE & TECHNOLOGY GOVERNMENT OF INDIA
5	School Name:	MPPS (G) T/M & E/M Sirpur -T
6	Address School :	Arab Mohalla, Near: Post office Sirpur -T, Dst: KB. Asifabad Telangana
7	Signature of School principal with stamp	 HEADMASTER MPPS (G) T/M & E/M SIRPUR -T Dist. Kumram Bheem Asifabad
8	Mobile Number :	9492744789
9	Date of Program:	28.8.2019
10	Number of Student Participated	46
11	Model is Registered in School Science Book	Yes
12	Feed back of the School Science Teacher /Students	Good/Excellent
13	Signature of Project Trainer	
14	Signature of Project Investigator	

P-69

S.No.	Description	Details
1	Organization Name:	MULTIPURPOSE AWARENESS SOCIETY
2	Project Name:	ARTIFICIAL INTELLIGENCE BASED LINE FOLLOWING ROBOTS
3	Theme :	DEMONSTRATION ON MODEL OF LATEST TECHNOLOGY RELEVANT ROBOT AND AI
4	Sponsored by:	DEPARTMENT OF SCIENCE & TECHNOLOGY GOVERNMENT OF INDIA
5	School Name:	MP UPS Girls' U/M Sirpur -T.
6	Address School :	Village SIRPUR -T Eman
7	Signature of School principal with stamp	 Headmaster MP UPS, Girls U/M, Sirpur -T Dist. Kumram Bheem Asifabad
8	Mobile Number :	9948495565
9	Date of Program:	28.08.2019
10	Number of Student Participated	29
11	Model is Registered in School Science Book	-Yes
12	Feed back of the School Science Teacher /Students	Good/Excellent Good.
13	Signature of Project Trainer	
14	Signature of Project Investigator	

ata_rahman_65@yahoo.com



**ARTIFICIAL INTELLIGENCE BASED LINE FOLLOWER ROBOT
FOR RURAL SCHOOL STUDENTS IN KOMARAM BHEEM ASIFABAD
DISTRICT, TELANGANA STATE**
PROJECT DEMONSTRATION AND SCHOOL EXPERIMENT ACTIVITIES
Certificates

P-122

S.No.	Description	Details
1	Organization Name:	MULTIPURPOSE AWARENESS SOCIETY
2	Project Name:	ARTIFICIAL INTELLIGENCE BASED LINE FOLLOWING ROBOTS
3	Theme :	DEMONSTRATION ON MODEL OF LATEST TECHNOLOGY RELEVANT ROBOT AND AI
4	Sponsored by:	DEPARTMENT OF SCIENCE & TECHNOLOGY GOVERNMENT OF INDIA
5	School Name:	ZPSS BOYS ASIFABAD
6	Address School :	ASIFABAD opp: DCP office Komurambheem Asifabad District.
7	Signature of School principal with stamp	 Head Master Gr. II Z.P.S.S. (Boys) ASIFABAD, Dist. Komurambheem Asifabad Dist.
8	Mobile Number	914611111111
9	Date of Program:	27/08/2019
10	Number of Student Participated	120
11	Model is Registered in School Science Book	Yes
12	Feed back of the School Science Teacher /Students	Good/Excellent
13	Signature of Project Trainer	
14	Signature of Project Investigator	

P-123

S.No.	Description	Details
1	Organization Name:	MULTIPURPOSE AWARENESS SOCIETY
2	Project Name:	ARTIFICIAL INTELLIGENCE BASED LINE FOLLOWING ROBOTS
3	Theme :	DEMONSTRATION ON MODEL OF LATEST TECHNOLOGY RELEVANT ROBOT AND AI
4	Sponsored by:	DEPARTMENT OF SCIENCE & TECHNOLOGY GOVERNMENT OF INDIA
5	School Name:	TSWRS/IC (B), Asifabad
6	Address School :	Opposite Forest office, Jankapur, Asifabad, Komurambheem Asifabad Dist.
7	Signature of School principal with stamp	 Principal TSWRS/IC (B) Asifabad Komurambheem Dist.
8	Mobile Number	9704550162
9	Date of Program:	27-08-2019
10	Number of Student Participated	240
11	Model is Registered in School Science Book	Yes
12	Feed back of the School Science Teacher /Students	Good/Excellent
13	Signature of Project Trainer	
14	Signature of Project Investigator	

P-104

S.No.	Description	Details
1	Organization Name:	MULTIPURPOSE AWARENESS SOCIETY
2	Project Name:	ARTIFICIAL INTELLIGENCE BASED LINE FOLLOWING ROBOTS
3	Theme :	DEMONSTRATION ON MODEL OF LATEST TECHNOLOGY RELEVANT ROBOT AND AI
4	Sponsored by:	DEPARTMENT OF SCIENCE & TECHNOLOGY GOVERNMENT OF INDIA
5	School Name:	Z.P.S.S, Jankapur
6	Address School :	Z.P.S.S, Jankapur Asifabad - 504 293 (T.S)
7	Signature of School principal with stamp	 I/c, Z.P.S.S. Jankapur, Asifabad, Dist. Komurambheem Asifabad
8	Mobile Number	9959466536
9	Date of Program:	27-08-2019
10	Number of Student Participated	120
11	Model is Registered in School Science Book	Yes
12	Feed back of the School Science Teacher /Students	Good/Excellent
13	Signature of Project Trainer	
14	Signature of Project Investigator	

P-105

S.No.	Description	Details
1	Organization Name:	MULTIPURPOSE AWARENESS SOCIETY
2	Project Name:	ARTIFICIAL INTELLIGENCE BASED LINE FOLLOWING ROBOTS
3	Theme :	DEMONSTRATION ON MODEL OF LATEST TECHNOLOGY RELEVANT ROBOT AND AI
4	Sponsored by:	DEPARTMENT OF SCIENCE & TECHNOLOGY GOVERNMENT OF INDIA
5	School Name:	Mpps Oodpally
6	Address School :	Sirpur Kaganagar Komurambheem (ASP)
7	Signature of School principal with stamp	 HEADMASTER Govt MPPS School Sirpur Kaganagar Dist. Komurambheem Asif
8	Mobile Number	
9	Date of Program:	28-08-2019
10	Number of Student Participated	25
11	Model is Registered in School Science Book	Yes
12	Feed back of the School Science Teacher /Students	Good/Excellent
13	Signature of Project Trainer	
14	Signature of Project Investigator	



**ARTIFICIAL INTELLIGENCE BASED LINE FOLLOWER ROBOT
FOR RURAL SCHOOL STUDENTS IN KOMARAM BHEEM ASIFABAD
DISTRICT, TELANGANA STATE**
PROJECT DEMONSTRATION AND SCHOOL EXPERIMENT ACTIVITIES
Certificates

SCHOOL AWARENESS PROGRAMS REGISTRATION FOAM

S.No.	Description	Details
1	Organization Name:	MULTIPURPOSE AWARENESS SOCIETY
2	Project Name:	ARTIFICIAL INTELLIGENCE BASED LINE FOLLOWING ROBOTS
3	Theme :	DEMONSTRATION ON MODEL OF LATEST TECHNOLOGY RELEVANT ROBOT AND AI
4	Sponsored by:	DEPARTMENT OF SCIENCE & TECHNOLOGY GOVERNMENT OF INDIA
5	School Name:	ZPSS (girls) Asifabad
6	Address School :	ZPSS (girls) Asifabad Rajeev nagar 1- Asifabad
7	Signature of School principal with stamp	S. Valandera HEADMASTER ZPSS GIRLS ASIFABAD Dist. Komurambheem Asifabad
8	Mobile Number :	9492260826
9	Date of Program:	27/08/2019
10	Number of Student Participated	130
11	Model is Registered in School Science Book	Yes
12	Feed back of the School Science Teacher /Students	Good/Excellent
13	Signature of Project Trainer	Nani
14	Signature of Project Investigator	Bellef

School Awareness Programs registration

S.No.	Description	Details
1	Organization Name	Multipurpose Awareness Society, Hyd Telangana
2	Project Name	AI Based Line follower Robotic
3	Sponsored by	N.M. ICPS, DST, Govt of India
4	School Name	Govt. PS - Kagas Nagar.
5	School Address	VIII, Md:- Kagas Nagar Dist :- Komurambheem (AsE)
6	Signature of School Principal with Stamp	HEADMASTER Govt/MPPB School Sirur Kagasnagar Dist. Komurambheem Asifabad
7	Mobile Number	9708619733
8	Program Date	27-08-2019
9	Science Model is registered in school science book	Yes/Sign:
10	Feedback demonstration project	Good/Excellent
11	Signature of Project Trainer	Nani
12	Signature of Project Investigator	Bellef

SCHOOL AWARENESS PROGRAMS REGISTRATION FOAM

S.No.	Description	Details
1	Organization Name:	MULTIPURPOSE AWARENESS SOCIETY
2	Project Name:	ARTIFICIAL INTELLIGENCE BASED LINE FOLLOWING ROBOTS
3	Theme :	DEMONSTRATION ON MODEL OF LATEST TECHNOLOGY RELEVANT ROBOT AND AI
4	Sponsored by:	DEPARTMENT OF SCIENCE & TECHNOLOGY GOVERNMENT OF INDIA
5	School Name:	MPPS URDU ASIFABAD
6	Address School :	opp Govt Hospital Asifabad
7	Signature of School principal with stamp	HEAD MASTER M.P.S. Asifabad U/M M.P. Asifabad Dist. Adilabad (TS)
8	Mobile Number	8341250490
9	Date of Program:	27-8-2019
10	Number of Student Participated	42
11	Model is Registered in School Science Book	Yes
12	Feed back of the School Science Teacher /Students	Good/Excellent
13	Signature of Project Trainer	Khushal
14	Signature of Project Investigator	Bellef

SCHOOL AWARENESS PROGRAMS REGISTRATION FOAM

S.No.	Description	Details
1	Organization Name:	MULTIPURPOSE AWARENESS SOCIETY
2	Project Name:	ARTIFICIAL INTELLIGENCE BASED LINE FOLLOWING ROBOTS
3	Theme :	DEMONSTRATION ON MODEL OF LATEST TECHNOLOGY RELEVANT ROBOT AND AI
4	Sponsored by:	DEPARTMENT OF SCIENCE & TECHNOLOGY GOVERNMENT OF INDIA
5	School Name:	Govt Ashram School (Boys) Asifabad.
6	Address School :	Asifabad opp. forest office Komurambheem Asifabad
7	Signature of School principal with stamp	-
8	Mobile Number	9963622572
9	Date of Program:	27-08-2019
10	Number of Student Participated	30
11	Model is Registered in School Science Book	Yes
12	Feed back of the School Science Teacher /Students	Good/Excellent
13	Signature of Project Trainer	Khushal
14	Signature of Project Investigator	Bellef

HEAD MASTER
G.A.H.S. (B), Asifabad



**ARTIFICIAL INTELLIGENCE BASED LINE FOLLOWER ROBOT
FOR RURAL SCHOOL STUDENTS IN KOMARAM BHEEM ASIFABAD
DISTRICT, TELANGANA STATE**
PROJECT DEMONSTRATION AND SCHOOL EXPERIMENT ACTIVITIES
Certificates

School Awareness Programs registration

S.No.	Description	Details
1	Organization Name	Multipurpose Awareness Society, Hyd Telangana
2	Project Name	AI Based Line follower Robotic
3	Sponsored by	N.M. ICPS, DST, Govt of India
4	School Name	Govt. UPS. WORD No. 14 (KZR)
5	School Address	Sirpur Kargaz Nagar, Dist. Komurambheem (Asf)
6	Signature of School Principal with Stamp	
7	Mobile Number	9979261970
8	Program Date	26-08-2019
9	Science Model is registered in school science book	Yes/Sign:
10	Feedback demonstration project	Good/Excellent
11	Signature of Project Trainer	
12	Signature of Project Investigator	

SCHOOL AWARENESS PROGRAMS REGISTRATION FOAM

S.No.	Description	Details
1	Organization Name	MULTIPURPOSE AWARENESS SOCIETY
2	Project Name	ARTIFICIAL INTELLIGENCE BASED LINE FOLLOWING ROBOTS
3	Theme :	DEMONSTRATION ON MODEL OF LATEST TECHNOLOGY RELEVANT ROBOT AND AI
4	Sponsored by:	DEPARTMENT OF SCIENCE & TECHNOLOGY GOVERNMENT OF INDIA
5	School Name:	Mpps. Word No. 5
6	Address School :	Vill, mdl:- Sirpur (KZR) Dist :- Komurambheem (Asf)
7	Signature of school principal with stamp	
8	Mobile Number :	
9	Date of Program:	26-08-2019
10	Number of Student Participated	36
11	Model is Registered in school science book	Yes
12	Feed Back of the School Science Teacher /Students	Good/Excellent
13	Signature of Project Trainer	
14	Signature of Project Investigator	

SCHOOL AWARENESS PROGRAMS REGISTRATION FOAM

S.No.	Description	Details
1	Organization Name:	MULTIPURPOSE AWARENESS SOCIETY
2	Project Name:	ARTIFICIAL INTELLIGENCE BASED LINE FOLLOWING ROBOTS
3	Theme :	DEMONSTRATION ON MODEL OF LATEST TECHNOLOGY RELEVANT ROBOT AND AI
4	Sponsored by:	DEPARTMENT OF SCIENCE & TECHNOLOGY GOVERNMENT OF INDIA
5	School Name:	Vidhyadhar High School
6	Address School :	Binagar Colony, Kargaznagar
7	Signature of School principal with stamp	
8	Mobile Number :	261819
9	Date of Program:	26/8/19
10	Number of Student Participated	12
11	Model is Registered in School Science Book	Yes
12	Feed back of the School Science Teacher /Students	Good/Excellent
13	Signature of Project Trainer	
14	Signature of Project Investigator	

School Awareness Programs registration

S.No.	Description	Details
1	Organization Name	Multipurpose Awareness Societv. Hyd Telangana
2	Project Name	AI Based Line follower Robotic
3	Sponsored by	N.M. ICPS, DST, Govt of India
4	School Name	MPPS. Nandiguda
5	School Address	Vill: Nandiguda. mdl. Sirpur KZR Dist. Komurambheem (Asf)
6	Signature of School Principal with Stamp	
7	Mobile Number	9805432200
8	Program Date	26-08-2019
9	Science Model is registered in school science book	Yes/Sign:
10	Feedback demonstration project	Good/Excellent
11	Signature of Project Trainer	
12	Signature of Project Investigator	



**ARTIFICIAL INTELLIGENCE BASED LINE FOLLOWER ROBOT
FOR RURAL SCHOOL STUDENTS IN KOMARAM BHEEM ASIFABAD
DISTRICT, TELANGANA STATE**
PROJECT DEMONSTRATION AND SCHOOL EXPERIMENT ACTIVITIES
Certificates

P-55

SCHOOL AWARENESS PROGRAMS REGISTRATION FOAM

S.No.	Description	Details
1	Organization Name:	MULTIPURPOSE AWARENESS SOCIETY
2	Project Name:	ARTIFICIAL INTELLIGENCE BASED LINE FOLLOWING ROBOTS
3	Theme :	DEMONSTRATION ON MODEL OF LATEST TECHNOLOGY RELEVANT ROBOT AND AI
4	Sponsored by:	DEPARTMENT OF SCIENCE & TECHNOLOGY GOVERNMENT OF INDIA
5	School Name:	Mc Guffey Elm School
6	Address School :	3-6-1, Sirsilk chook Kaggaz Nagar
7	Signature of School principal with stamp	 Principal McGuffey International School Sirsilk chook, Kaggaznagar, Dist. Kumarambheem Asf.
8	Mobile Number :	9440372
9	Date of Program:	21-08-19
10	Number of Student Participated	100
11	Model is Registered in School Science Book	Yes
12	Feed back of the School Science Teacher /Students	Good/Excellent
13	Signature of Project Trainer	
14	Signature of Project Investigator	

P-56

SCHOOL AWARENESS PROGRAMS REGISTRATION FOAM

S.No.	Description	Details
1	Organization Name:	MULTIPURPOSE AWARENESS SOCIETY
2	Project Name:	ARTIFICIAL INTELLIGENCE BASED LINE FOLLOWING ROBOTS
3	Theme :	DEMONSTRATION ON MODEL OF LATEST TECHNOLOGY RELEVANT ROBOT AND AI
4	Sponsored by:	DEPARTMENT OF SCIENCE & TECHNOLOGY GOVERNMENT OF INDIA
5	School Name:	Chaitanya vidya mandir
6	Address School :	Chinthaguda (K) KZR M: KZR, Dist: Komarambheem
7	Signature of School principal with stamp	 Headmaster Chaitanya Vidya Mandir EM & TM Chinthaguda (K), Mdi, Kaggaznagar Dist: Kumaram Bheem Asifabad
8	Mobile Number :	9948097232
9	Date of Program:	21-08-2019
10	Number of Student Participated	30
11	Model is Registered in School Science Book	Yes
12	Feed back of the School Science Teacher /Students	Good/Excellent
13	Signature of Project Trainer	
14	Signature of Project Investigator	

P-57

SCHOOL AWARENESS PROGRAMS REGISTRATION FOAM

S.No.	Description	Details
1	Organization Name:	MULTIPURPOSE AWARENESS SOCIETY
2	Project Name:	ARTIFICIAL INTELLIGENCE BASED LINE FOLLOWING ROBOTS
3	Theme :	DEMONSTRATION ON MODEL OF LATEST TECHNOLOGY RELEVANT ROBOT AND AI
4	Sponsored by:	DEPARTMENT OF SCIENCE & TECHNOLOGY GOVERNMENT OF INDIA
5	School Name:	Sree Vishwa Shanti Resi High School Patrol Pump, Kaggaznagar K.B. Amr. T.S. 504296
6	Address School :	Sree Vishwa Shanti High School E.M. Petrolpump, Kaggaznagar, Dist. Kumarambheem Asifabad.
7	Signature of School principal with stamp	 Headmaster Sree Vishwa Shanti High School Patrol Pump, Kaggaznagar Dist. Kumaram Bheem Asf.
8	Mobile Number :	944048074
9	Date of Program:	22-08-2019
10	Number of Student Participated	100 students
11	Model is Registered in School Science Book	yes
12	Feed back of the School Science Teacher /Students	Good/Excellent
13	Signature of Project Trainer	
14	Signature of Project Investigator	

P-58

School Awareness Programs registration

S.No.	Description	Details
1	Organization Name	Multipurpose Awareness Society, Hyd Telangana
2	Project Name	AI Based Line follower Robotic
3	Sponsored by	N.M. ICPS, DST, Govt of India
4	School Name	Mpps Ward No:13 K Kaggaznagar
5	School Address	Sirpur Kaggaznagar Kumarambheem
6	Signature of School Principal with Stamp	 HEADMASTER GovtMPPS School Sirpur Kaggaznagar Dist. Kumaram Bheem Asf.
7	Mobile Number	88066131619
8	Program Date	23-08-2019
9	Science Model is registered in school science book	Yes/Sign:
10	Feedback demonstration project	Good/Excellent
11	Signature of Project Trainer	
12	Signature of Project Investigator	



ARTIFICIAL INTELLIGENCE BASED LINE FOLLOWER ROBOT FOR RURAL SCHOOL STUDENTS IN KOMARAM BHEEM ASIFABAD DISTRICT, TELANGANA STATE
PROJECT DEMONSTRATION AND SCHOOL EXPERIMENT ACTIVITIES
Certificates

P-79

SCHOOL AWARENESS PROGRAM REGISTRATION FOAM

S.No.	Description	Details
1	Organization Name:	MULTIPURPOSE AWARENESS SOCIETY
2	Project Name:	ARTIFICIAL INTELLIGENCE BASED LINE FOLLOWING ROBOTS
3	Theme:	DEMONSTRATION ON MODEL OF LATEST TECHNOLOGY RELEVANT ROBOT AND AI
4	Sponsored by:	DEPARTMENT OF SCIENCE & TECHNOLOGY GOVERNMENT OF INDIA
5	School Name:	Shishu Mandir High School
6	Address School:	Shishu Mandir High School Sir Silk colony Kaghnaznagar 504296
7	Signature of School principal with stamp	 HEAD MASTER Shishu Mandir High School Sir Silk Colony Kaghnaznagar
8	Mobile Number:	9016958061
9	Date of Program:	20/08/2019
10	Number of Student Participated	90
11	Model is Registered in School Science Book	yes
12	Feed back of the School Science Teacher /Students	Good/Excellent
13	Signature of Project Trainer	
14	Signature of Project Investigator	



P-90

SCHOOL AWARENESS PROGRAM REGISTRATION FOAM

S.No.	Description	Details
1	Organization Name:	MULTIPURPOSE AWARENESS SOCIETY
2	Project Name:	ARTIFICIAL INTELLIGENCE BASED LINE FOLLOWING ROBOTS
3	Theme:	DEMONSTRATION ON MODEL OF LATEST TECHNOLOGY RELEVANT ROBOT AND AI
4	Sponsored by:	DEPARTMENT OF SCIENCE & TECHNOLOGY GOVERNMENT OF INDIA
5	School Name:	
6	Address School:	Govt primary RB Urdu. LBS market Sirsilk colony. SK22 K.B. Asifabad. T.S.
7	Signature of School principal with stamp	 Headmaster Govt Primary RB Urdu School Kaghnaznagar-504296
8	Mobile Number:	9347376966
9	Date of Program:	20-08-2019
10	Number of Student Participated	35
11	Model is Registered in School Science Book	yes
12	Feed back of the School Science Teacher /Students	Good/Excellent
13	Signature of Project Trainer	
14	Signature of Project Investigator	



**ARTIFICIAL INTELLIGENCE BASED LINE FOLLOWER ROBOT
FOR RURAL SCHOOL STUDENTS IN KOMARAM BHEEM ASIFABAD
DISTRICT, TELANGANA STATE**
PROJECT DEMONSTRATION AND SCHOOL EXPERIMENT ACTIVITIES
Certificates

P-118

SCHOOL AWARENESS PROGRAMS REGISTRATION FOAM

S.No.	Description	Details
1	Organization Name:	MULTIPURPOSE AWARENESS SOCIETY
2	Project Name:	ARTIFICIAL INTELLIGENCE BASED LINE FOLLOWING ROBOTS
3	Theme :	DEMONSTRATION ON MODEL OF LATEST TECHNOLOGY RELEVANT ROBOT AND AI
4	Sponsored by:	DEPARTMENT OF SCIENCE & TECHNOLOGY GOVERNMENT OF INDIA
5	School Name:	Mpps Balagala
6	Address School :	Sirpur Kagaznagar, Komurambheem (ASF)
7	Signature of School principal with stamp	HEADMASTER Govt. MPPS School Sirpur Kagaznagar Dist. Komurambheem Tel. Andhra Pradesh
8	Mobile Number :	—
9	Date of Program:	29-08-2019
10	Number of Student Participated	28
11	Model is Registered in School Science Book	Yes
12	Feed back of the School Science Teacher /Students	Good/Excellent
13	Signature of Project Trainer	Nhi
14	Signature of Project Investigator	Beleg

P-119

SCHOOL AWARENESS PROGRAMS REGISTRATION FOAM

S.No.	Description	Details
1	Organization Name:	MULTIPURPOSE AWARENESS SOCIETY
2	Project Name:	ARTIFICIAL INTELLIGENCE BASED LINE FOLLOWING ROBOTS
3	Theme :	DEMONSTRATION ON MODEL OF LATEST TECHNOLOGY RELEVANT ROBOT AND AI
4	Sponsored by:	DEPARTMENT OF SCIENCE & TECHNOLOGY GOVERNMENT OF INDIA
5	School Name:	Mpps. Durgaiah wada.
6	Address School :	Vill. Durgaiah Wada, Md. Sirpur (Kaz) Kagaz Nagar Dist. Komurambheem (ASF)
7	Signature of School principal with stamp	HEADMASTER MPPS School Kagaznagar Dist. Komurambheem Tel. Andhra Pradesh
8	Mobile Number :	—
9	Date of Program:	29-08-2019
10	Number of Student Participated	29
11	Model is Registered in School Science Book	Yes
12	Feed back of the School Science Teacher /Students	Good/Excellent
13	Signature of Project Trainer	Nhi
14	Signature of Project Investigator	Beleg

P-120

SCHOOL AWARENESS PROGRAMS REGISTRATION FOAM

S.No.	Description	Details
1	Organization Name:	MULTIPURPOSE AWARENESS SOCIETY
2	Project Name:	ARTIFICIAL INTELLIGENCE BASED LINE FOLLOWING ROBOTS
3	Theme :	DEMONSTRATION ON MODEL OF LATEST TECHNOLOGY RELEVANT ROBOT AND AI
4	Sponsored by:	DEPARTMENT OF SCIENCE & TECHNOLOGY GOVERNMENT OF INDIA
5	School Name:	Mpps. AREGUDA (A)
6	Address School :	Vill. Areguda Md. Sirpur (Kaz) Dist. Komurambheem (ASF)
7	Signature of School principal with stamp	HEADMASTER Govt. MPPS School Sirpur Kagaznagar Dist. Komurambheem Tel. Andhra Pradesh
8	Mobile Number :	7013986139
9	Date of Program:	29-08-2019
10	Number of Student Participated	28
11	Model is Registered in School Science Book	Yes
12	Feed back of the School Science Teacher /Students	Good/Excellent
13	Signature of Project Trainer	Nhi
14	Signature of Project Investigator	Beleg

P-121

SCHOOL AWARENESS PROGRAMS REGISTRATION FOAM

S.No.	Description	Details
1	Organization Name:	MULTIPURPOSE AWARENESS SOCIETY
2	Project Name:	ARTIFICIAL INTELLIGENCE BASED LINE FOLLOWING ROBOTS
3	Theme :	DEMONSTRATION ON MODEL OF LATEST TECHNOLOGY RELEVANT ROBOT AND AI
4	Sponsored by:	DEPARTMENT OF SCIENCE & TECHNOLOGY GOVERNMENT OF INDIA
5	School Name:	Mpps Basaguda.
6	Address School :	Sirpur Kagaznagar, Komurambheem (ASF)
7	Signature of School principal with stamp	HEADMASTER Govt. MPPS School Sirpur Kagaznagar Dist. Komurambheem Tel. Andhra Pradesh
8	Mobile Number :	—
9	Date of Program:	29-08-2019
10	Number of Student Participated	35
11	Model is Registered in School Science Book	Yes
12	Feed back of the School Science Teacher /Students	Good/Excellent
13	Signature of Project Trainer	Nhi
14	Signature of Project Investigator	Beleg



**ARTIFICIAL INTELLIGENCE BASED LINE FOLLOWER ROBOT
FOR RURAL SCHOOL STUDENTS IN KOMARAM BHEEM ASIFABAD
DISTRICT, TELANGANA STATE**
PROJECT DEMONSTRATION AND SCHOOL EXPERIMENT ACTIVITIES
Certificates

P-114

SCHOOL AWARENESS PROGRAMS REGISTRATION FOAM

S.No.	Description	Details
1	Organization Name:	MULTIPURPOSE AWARENESS SOCIETY
2	Project Name:	ARTIFICIAL INTELLIGENCE BASED LINE FOLLOWING ROBOTS
3	Theme :	DEMONSTRATION ON MODEL OF LATEST TECHNOLOGY RELEVANT ROBOT AND AI
4	Sponsored by:	DEPARTMENT OF SCIENCE & TECHNOLOGY GOVERNMENT OF INDIA
5	School Name:	MPPS. Gollaguda.
6	Address School :	Vill: Gollaguda, Md. Sirpur (K2R) Dist: Komurambheem (Asf)
7	Signature of School principal with stamp	 HEADMASTER MPPS School Kaghanagar Komaram Bheem Asf
8	Mobile Number :	9705631388
9	Date of Program:	29-08-2019
10	Number of Student Participated	25
11	Model is Registered in School Science Book	Yes
12	Feed back of the School Science Teacher /Students	Good/Excellent
13	Signature of Project Trainer	NM
14	Signature of Project Investigator	Bellef

P-115

SCHOOL AWARENESS PROGRAMS REGISTRATION FOAM

S.No.	Description	Details
1	Organization Name:	MULTIPURPOSE AWARENESS SOCIETY
2	Project Name:	ARTIFICIAL INTELLIGENCE BASED LINE FOLLOWING ROBOTS
3	Theme :	DEMONSTRATION ON MODEL OF LATEST TECHNOLOGY RELEVANT ROBOT AND AI
4	Sponsored by:	DEPARTMENT OF SCIENCE & TECHNOLOGY GOVERNMENT OF INDIA
5	School Name:	MPPS. Gannaram.
6	Address School :	Vill. Gannaram. Md. Sirpur Kagaz Nagar Dist. Komurambheem (Asf)
7	Signature of School principal with stamp	 HEADMASTER Govt MPPS School Sirpur Kagaz Nagar Dist. Komurambheem Asf
8	Mobile Number :	9573615201
9	Date of Program:	29-08-2019
10	Number of Student Participated	25
11	Model is Registered in School Science Book	Yes
12	Feed back of the School Science Teacher /Students	Good/Excellent
13	Signature of Project Trainer	NM
14	Signature of Project Investigator	Bellef

P-116

SCHOOL AWARENESS PROGRAMS REGISTRATION FOAM

S.No.	Description	Details
1	Organization Name:	MULTIPURPOSE AWARENESS SOCIETY
2	Project Name:	ARTIFICIAL INTELLIGENCE BASED LINE FOLLOWING ROBOTS
3	Theme :	DEMONSTRATION ON MODEL OF LATEST TECHNOLOGY RELEVANT ROBOT AND AI
4	Sponsored by:	DEPARTMENT OF SCIENCE & TECHNOLOGY GOVERNMENT OF INDIA
5	School Name:	MPPS. Mala seetha nagar.
6	Address School :	Vill. Mala Seetha Nagar. Md. Sirpur Kagaz Nagar Dist. Komurambheem (Asf)
7	Signature of School principal with stamp	 HEADMASTER Govt MPPS School Sirpur Kagaz Nagar Dist. Komurambheem Asf
8	Mobile Number :	9623194550
9	Date of Program:	29-08-2019
10	Number of Student Participated	26
11	Model is Registered in School Science Book	Yes
12	Feed back of the School Science Teacher /Students	Good/Excellent
13	Signature of Project Trainer	NM
14	Signature of Project Investigator	Bellef

P-117



SCHOOL AWARENESS PROGRAMS REGISTRATION FOAM

S.No.	Description	Details
1	Organization Name:	MULTIPURPOSE AWARENESS SOCIETY
2	Project Name:	ARTIFICIAL INTELLIGENCE BASED LINE FOLLOWING ROBOTS
3	Theme :	DEMONSTRATION ON MODEL OF LATEST TECHNOLOGY RELEVANT ROBOT AND AI
4	Sponsored by:	DEPARTMENT OF SCIENCE & TECHNOLOGY GOVERNMENT OF INDIA
5	School Name:	MPPS. Shivapur
6	Address School :	Vill. Shivapur Md. Sirpur Kagaz Nagar Dist. Komurambheem (Asf)
7	Signature of School principal with stamp	 HEADMASTER Govt MPPS School Sirpur Kagaz Nagar Dist. Komurambheem Asf
8	Mobile Number :	-
9	Date of Program:	29-08-2019
10	Number of Student Participated	34
11	Model is Registered in School Science Book	Yes
12	Feed back of the School Science Teacher /Students	Good/Excellent
13	Signature of Project Trainer	NM
14	Signature of Project Investigator	Bellef





**ARTIFICIAL INTELLIGENCE BASED LINE FOLLOWER ROBOT
FOR RURAL SCHOOL STUDENTS IN KOMARAM BHEEM ASIFABAD
DISTRICT, TELANGANA STATE**
PROJECT DEMONSTRATION AND SCHOOL EXPERIMENT ACTIVITIES
Certificates

P-114

S.No.	Description	Details
1	Organization Name:	MULTIPURPOSE AWARENESS SOCIETY
2	Project Name:	ARTIFICIAL INTELLIGENCE BASED LINE FOLLOWING ROBOTS
3	Theme :	DEMONSTRATION ON MODEL OF LATEST TECHNOLOGY RELEVANT ROBOT AND AI
4	Sponsored by:	DEPARTMENT OF SCIENCE & TECHNOLOGY GOVERNMENT OF INDIA
5	School Name:	MPPS. Gollaguda.
6	Address School :	Vill: Gollaguda, Md. Sirpur (Kaz)
7	Signature of School principal with stamp	Dist: Komurambheem (Asf)  
8	Mobile Number :	9705631388
9	Date of Program:	29-08-2019
10	Number of Student Participated	25
11	Model is Registered in School Science Book	Yes
12	Feed back of the School Science Teacher /Students	Good/Excellent
13	Signature of Project Trainer	NM
14	Signature of Project Investigator	Bellef

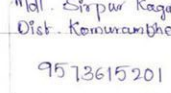
P-115

S.No.	Description	Details
1	Organization Name:	MULTIPURPOSE AWARENESS SOCIETY
2	Project Name:	ARTIFICIAL INTELLIGENCE BASED LINE FOLLOWING ROBOTS
3	Theme :	DEMONSTRATION ON MODEL OF LATEST TECHNOLOGY RELEVANT ROBOT AND AI
4	Sponsored by:	DEPARTMENT OF SCIENCE & TECHNOLOGY GOVERNMENT OF INDIA
5	School Name:	MPPS. Gannagan.
6	Address School :	Vill. Gannagan, Md. Sirpur Kaza Nagari
7	Signature of School principal with stamp	Dist: Komurambheem (Asf)  
8	Mobile Number :	9573615201
9	Date of Program:	29-08-2019
10	Number of Student Participated	25
11	Model is Registered in School Science Book	Yes
12	Feed back of the School Science Teacher /Students	Good/Excellent
13	Signature of Project Trainer	NM
14	Signature of Project Investigator	Bellef

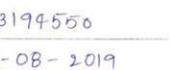

P-116

S.No.	Description	Details
1	Organization Name:	MULTIPURPOSE AWARENESS SOCIETY
2	Project Name:	ARTIFICIAL INTELLIGENCE BASED LINE FOLLOWING ROBOTS
3	Theme :	DEMONSTRATION ON MODEL OF LATEST TECHNOLOGY RELEVANT ROBOT AND AI
4	Sponsored by:	DEPARTMENT OF SCIENCE & TECHNOLOGY GOVERNMENT OF INDIA
5	School Name:	MPPS. Mala seetha nagar.
6	Address School :	Vill. Mala Seetha Nagar, Md. Sirpur Kaza Nagari
7	Signature of School principal with stamp	Dist: Komurambheem (Asf)  
8	Mobile Number :	9623194550
9	Date of Program:	29-08-2019
10	Number of Student Participated	26
11	Model is Registered in School Science Book	Yes
12	Feed back of the School Science Teacher /Students	Good/Excellent
13	Signature of Project Trainer	NM
14	Signature of Project Investigator	Bellef

P-117

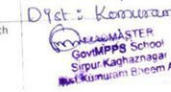
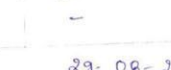
S.No.	Description	Details
1	Organization Name:	MULTIPURPOSE AWARENESS SOCIETY
2	Project Name:	ARTIFICIAL INTELLIGENCE BASED LINE FOLLOWING ROBOTS
3	Theme :	DEMONSTRATION ON MODEL OF LATEST TECHNOLOGY RELEVANT ROBOT AND AI
4	Sponsored by:	DEPARTMENT OF SCIENCE & TECHNOLOGY GOVERNMENT OF INDIA
5	School Name:	MPPS. Shivapur
6	Address School :	Vill. Shivapur, Md. Sirpur Kaza Nagari
7	Signature of School principal with stamp	Dist: Komurambheem (Asf)  
8	Mobile Number :	-
9	Date of Program:	29-08-2019
10	Number of Student Participated	34
11	Model is Registered in School Science Book	Yes
12	Feed back of the School Science Teacher /Students	Good/Excellent
13	Signature of Project Trainer	NM
14	Signature of Project Investigator	Bellef



ARTIFICIAL INTELLIGENCE BASED LINE FOLLOWER ROBOT FOR RURAL SCHOOL STUDENTS IN KOMARAM BHEEM ASIFABAD DISTRICT, TELANGANA STATE
PROJECT DEMONSTRATION AND SCHOOL EXPERIMENT ACTIVITIES
Certificates

P-110

S.No.	Description	Details
1	Organization Name:	MULTIPURPOSE AWARENESS SOCIETY
2	Project Name:	ARTIFICIAL INTELLIGENCE BASED LINE FOLLOWING ROBOTS
3	Theme :	DEMONSTRATION ON MODEL OF LATEST TECHNOLOGY RELEVANT ROBOT AND AI
4	Sponsored by:	DEPARTMENT OF SCIENCE & TECHNOLOGY GOVERNMENT OF INDIA
5	School Name:	MPPS Sarpal U/M
6	Address School :	Sirpur - T
7	Signature of School principal with stamp	
8	Mobile Number :	
9	Date of Program:	28/08/2019
10	Number of Student Participated	
11	Model is Registered in School Science Book	78
12	Feed back of the School Science Teacher /Students	Good/Excellent
13	Signature of Project Trainer	<i>K. Prasad</i>
14	Signature of Project Investigator	<i>Beleef</i>

P-111

S.No.	Description	Details
1	Organization Name:	MULTIPURPOSE AWARENESS SOCIETY
2	Project Name:	ARTIFICIAL INTELLIGENCE BASED LINE FOLLOWING ROBOTS
3	Theme :	DEMONSTRATION ON MODEL OF LATEST TECHNOLOGY RELEVANT ROBOT AND AI
4	Sponsored by:	DEPARTMENT OF SCIENCE & TECHNOLOGY GOVERNMENT OF INDIA
5	School Name:	Govt. Ashram High School (Girls)
6	Address School :	Govt. A.H.S (G), Sirpur(T), Kumaram Bheem Asifabad (Dist).
7	Signature of School principal with stamp	
8	Mobile Number :	9440233630
9	Date of Program:	28/08/2019
10	Number of Student Participated	382
11	Model is Registered in School Science Book	Yes
12	Feed back of the School Science Teacher /Students	Good/Excellent
13	Signature of Project Trainer	<i>A. Prasad</i>
14	Signature of Project Investigator	<i>Beleef</i>

P-112

S.No.	Description	Details
1	Organization Name:	MULTIPURPOSE AWARENESS SOCIETY
2	Project Name:	ARTIFICIAL INTELLIGENCE BASED LINE FOLLOWING ROBOTS
3	Theme :	DEMONSTRATION ON MODEL OF LATEST TECHNOLOGY RELEVANT ROBOT AND AI
4	Sponsored by:	DEPARTMENT OF SCIENCE & TECHNOLOGY GOVERNMENT OF INDIA
5	School Name:	MPPS. Wallakonda
6	Address School :	Vill. Wallakonda, Mdl. Sirpur Kagan Nagar, Dist. Komaram Bheem (A.S.F)
7	Signature of School principal with stamp	
8	Mobile Number	9705613913
9	Date of Program:	29-08-2019
10	Number of Student Participated	32
11	Model is Registered in School Science Book	Yes
12	Feed back of the School Science Teacher /Students	Good/Excellent
13	Signature of Project Trainer	<i>N.M.</i>
14	Signature of Project Investigator	<i>Beleef</i>

P-113

S.No.	Description	Details
1	Organization Name:	MULTIPURPOSE AWARENESS SOCIETY
2	Project Name:	ARTIFICIAL INTELLIGENCE BASED LINE FOLLOWING ROBOTS
3	Theme :	DEMONSTRATION ON MODEL OF LATEST TECHNOLOGY RELEVANT ROBOT AND AI
4	Sponsored by:	DEPARTMENT OF SCIENCE & TECHNOLOGY GOVERNMENT OF INDIA
5	School Name:	Mpps Gandhinagar
6	Address School :	Gandhinagar, Sirpur Kagan Nagar (Komaram Bheem)
7	Signature of School principal with stamp	
8	Mobile Number:	
9	Date of Program:	29-08-2019
10	Number of Student Participated	26
11	Model is Registered in School Science Book	Yes
12	Feed back of the School Science Teacher /Students	Good/Excellent
13	Signature of Project Trainer	<i>N.M.</i>
14	Signature of Project Investigator	<i>Beleef</i>



**ARTIFICIAL INTELLIGENCE BASED LINE FOLLOWER ROBOT
FOR RURAL SCHOOL STUDENTS IN KOMARAM BHEEM ASIFABAD
DISTRICT, TELANGANA STATE**
PROJECT DEMONSTRATION AND SCHOOL EXPERIMENT ACTIVITIES
Certificates

SCHOOL AWARENESS PROGRAMS REGISTRATION FOAM

S.No.	Description	Details
1	Organization Name:	MULTIPURPOSE AWARENESS SOCIETY
2	Project Name:	ARTIFICIAL INTELLIGENCE BASED LINE FOLLOWING ROBOTS
3	Theme :	DEMONSTRATION ON MODEL OF LATEST TECHNOLOGY RELEVANT ROBOT AND AI
4	Sponsored by:	DEPARTMENT OF SCIENCE & TECHNOLOGY GOVERNMENT OF INDIA
5	School Name:	Govt. AHS (B) Sirpur -T
6	Address School :	Sirpur -T KBM- Asifabad
7	Signature of School principal with stamp	 Sd/- Headmaster Govt. Ashram High School (B) Sirpur (T) Dist. Kumram Bheem Asifabad
8	Mobile Number :	9494028604
9	Date of Program:	28/08/2019
10	Number of Student Participated	38
11	Model is Registered in School Science Book	Yes
12	Feed back of the School Science Teacher /Students	Good/Excellent
13	Signature of Project Trainer	Nani
14	Signature of Project Investigator	Bireddy

SCHOOL AWARENESS PROGRAMS REGISTRATION FOAM

S.No.	Description	Details
1	Organization Name:	MULTIPURPOSE AWARENESS SOCIETY
2	Project Name:	ARTIFICIAL INTELLIGENCE BASED LINE FOLLOWING ROBOTS
3	Theme :	DEMONSTRATION ON MODEL OF LATEST TECHNOLOGY RELEVANT ROBOT AND AI
4	Sponsored by:	DEPARTMENT OF SCIENCE & TECHNOLOGY GOVERNMENT OF INDIA
5	School Name:	MPS - SOANPET Elm & Tm.
6	Address School :	SOANPET, SIRPUR -T
7	Signature of School principal with stamp	 Headmaster M.P.P.S. SOANPET/TM, Md. Sirpur-I
8	Mobile Number :	703627930
9	Date of Program:	28-08-2019
10	Number of Student Participated	31
11	Model is Registered in School Science Book	
12	Feed back of the School Science Teacher /Students	Good/Excellent Good.
13	Signature of Project Trainer	Nani
14	Signature of Project Investigator	Bireddy

SCHOOL AWARENESS PROGRAMS REGISTRATION FOAM

S.No.	Description	Details
1	Organization Name:	MULTIPURPOSE AWARENESS SOCIETY
2	Project Name:	ARTIFICIAL INTELLIGENCE BASED LINE FOLLOWING ROBOTS
3	Theme :	DEMONSTRATION ON MODEL OF LATEST TECHNOLOGY RELEVANT ROBOT AND AI
4	Sponsored by:	DEPARTMENT OF SCIENCE & TECHNOLOGY GOVERNMENT OF INDIA
5	School Name:	MPPS (G) T/M & E/M Sirpur -T
6	Address School :	Arab Mohalla, Near: Post office Sirpur-T, Dist: KB. Asifabad Telangana
7	Signature of School principal with stamp	 Headmaster M.P.P.S. (G) T/M & E/M Sirpur-T Dist. Kumram Bheem Asifabad
8	Mobile Number :	9492744789
9	Date of Program:	28-8-2019
10	Number of Student Participated	46
11	Model is Registered in School Science Book	Yes
12	Feed back of the School Science Teacher /Students	Good/Excellent
13	Signature of Project Trainer	Nani
14	Signature of Project Investigator	Bireddy

SCHOOL AWARENESS PROGRAMS REGISTRATION FOAM

S.No.	Description	Details
1	Organization Name:	MULTIPURPOSE AWARENESS SOCIETY
2	Project Name:	ARTIFICIAL INTELLIGENCE BASED LINE FOLLOWING ROBOTS
3	Theme :	DEMONSTRATION ON MODEL OF LATEST TECHNOLOGY RELEVANT ROBOT AND AI
4	Sponsored by:	DEPARTMENT OF SCIENCE & TECHNOLOGY GOVERNMENT OF INDIA
5	School Name:	MP UPS Girls' U/M Sirpur -T.
6	Address School :	Village SIRPUR -T Eranol
7	Signature of School principal with stamp	 Headmaster M.P. UPS, Girls U/M Sirpur-T Dist. Kumram Bheem Asifabad
8	Mobile Number :	9948495565
9	Date of Program:	28.08.2019
10	Number of Student Participated	29
11	Model is Registered in School Science Book	-Yes
12	Feed back of the School Science Teacher /Students	Good/Excellent Good.
13	Signature of Project Trainer	Nani
14	Signature of Project Investigator	Bireddy

ata_rahman65@yahoo.com



ARTIFICIAL INTELLIGENCE BASED LINE FOLLOWER ROBOT FOR RURAL SCHOOL STUDENTS IN KOMARAM BHEEM ASIFABAD DISTRICT, TELANGANA STATE
PROJECT DEMONSTRATION AND SCHOOL EXPERIMENT ACTIVITIES
Certificates

P.102

S.No.	Description	Details
1	Organization Name:	MULTIPURPOSE AWARENESS SOCIETY
2	Project Name:	ARTIFICIAL INTELLIGENCE BASED LINE FOLLOWING ROBOTS
3	Theme :	DEMONSTRATION ON MODEL OF LATEST TECHNOLOGY RELEVANT ROBOT AND AI
4	Sponsored by:	DEPARTMENT OF SCIENCE & TECHNOLOGY GOVERNMENT OF INDIA
5	School Name:	ZPSS BOYS ASIFABAD
6	Address School :	ASIFABAD OPP. DSP OFFICE Komaram Bheem Asifabad District.
7	Signature of School principal with stamp	 Headmaster Gr. II Z.P.S.S. (Boys) ASIFABAD, Dist. Komaram Bheem Asifabad Dist.
8	Mobile Number	9446160000
9	Date of Program:	27/08/2019
10	Number of Student Participated	120
11	Model is Registered in School Science Book	Yes.
12	Feed back of the School Science Teacher /Students	Good/Excellent
13	Signature of Project Trainer	Khalyal
14	Signature of Project Investigator	Beleg

P.103

S.No.	Description	Details
1	Organization Name:	MULTIPURPOSE AWARENESS SOCIETY
2	Project Name:	ARTIFICIAL INTELLIGENCE BASED LINE FOLLOWING ROBOTS
3	Theme :	DEMONSTRATION ON MODEL OF LATEST TECHNOLOGY RELEVANT ROBOT AND AI
4	Sponsored by:	DEPARTMENT OF SCIENCE & TECHNOLOGY GOVERNMENT OF INDIA
5	School Name:	TSWRS/SC (B), Asifabad
6	Address School :	Opposite Forest office, Jankapur, Asifabad Komaram Bheem Asifabad Dist.
7	Signature of School principal with stamp	 Principals TSWRS/SC (B) Asifabad Komaram Bheem Dist.
8	Mobile Number	9704550162
9	Date of Program:	27-08-2019
10	Number of Student Participated	240
11	Model is Registered in School Science Book	Yes
12	Feed back of the School Science Teacher /Students	Good/Excellent
13	Signature of Project Trainer	Khalyal
14	Signature of Project Investigator	Beleg

P.104

S.No.	Description	Details
1	Organization Name:	MULTIPURPOSE AWARENESS SOCIETY
2	Project Name:	ARTIFICIAL INTELLIGENCE BASED LINE FOLLOWING ROBOTS
3	Theme :	DEMONSTRATION ON MODEL OF LATEST TECHNOLOGY RELEVANT ROBOT AND AI
4	Sponsored by:	DEPARTMENT OF SCIENCE & TECHNOLOGY GOVERNMENT OF INDIA
5	School Name:	Z.P.S.S. Jankapur
6	Address School :	Z.P.S.S. Jankapur Asifabad - 504 293 (T.S)
7	Signature of School principal with stamp	 I/c. Gazetted Head Master ZPSS Jankapur, Asifabad, Dist. Komaram Bheem Asifabad
8	Mobile Number	9959466536
9	Date of Program:	27-08-2019
10	Number of Student Participated	120
11	Model is Registered in School Science Book	Yes.
12	Feed back of the School Science Teacher /Students	Good/Excellent
13	Signature of Project Trainer	Khalyal
14	Signature of Project Investigator	Beleg

P.105

S.No.	Description	Details
1	Organization Name:	MULTIPURPOSE AWARENESS SOCIETY
2	Project Name:	ARTIFICIAL INTELLIGENCE BASED LINE FOLLOWING ROBOTS
3	Theme :	DEMONSTRATION ON MODEL OF LATEST TECHNOLOGY RELEVANT ROBOT AND AI
4	Sponsored by:	DEPARTMENT OF SCIENCE & TECHNOLOGY GOVERNMENT OF INDIA
5	School Name:	Mpps Oodipally
6	Address School :	Sirpur Kagaznagar Komaram Bheem (A.S.F)
7	Signature of School principal with stamp	 HEADMASTER Govt Mpps School Sirpur Kagaznagar Dist. Komaram Bheem Asif
8	Mobile Number	-
9	Date of Program:	28-08-2019
10	Number of Student Participated	25
11	Model is Registered in School Science Book	Yes.
12	Feed back of the School Science Teacher /Students	Good/Excellent
13	Signature of Project Trainer	NH
14	Signature of Project Investigator	Beleg



**ARTIFICIAL INTELLIGENCE BASED LINE FOLLOWER ROBOT
FOR RURAL SCHOOL STUDENTS IN KOMARAM BHEEM ASIFABAD
DISTRICT, TELANGANA STATE**
PROJECT DEMONSTRATION AND SCHOOL EXPERIMENT ACTIVITIES
Certificates

SCHOOL AWARENESS PROGRAMS REGISTRATION FOAM

S.No.	Description	Details
1	Organization Name:	MULTIPURPOSE AWARENESS SOCIETY
2	Project Name:	ARTIFICIAL INTELLIGENCE BASED LINE FOLLOWING ROBOTS
3	Theme :	DEMONSTRATION ON MODEL OF LATEST TECHNOLOGY RELEVANT ROBOT AND AI
4	Sponsored by:	DEPARTMENT OF SCIENCE & TECHNOLOGY GOVERNMENT OF INDIA
5	School Name:	ZPSS (girls) Asifabad
6	Address School :	ZPSS (girls) Asifabad Rajeev nagar - Asifabad
7	Signature of School principal with stamp	S. Valudandevi HEADMASTER ZPSS GIRLS ASIFABAD The Komaram Bheem Asifabad
8	Mobile Number :	9492260826
9	Date of Program:	27/08/2019
10	Number of Student Participated	130
11	Model is Registered in School Science Book	Yes
12	Feed back of the School Science Teacher /Students	Good/Excellent
13	Signature of Project Trainer	AM
14	Signature of Project Investigator	Bellee

School Awareness Programs registration

S.No.	Description	Details
1	Organization Name	Multipurpose Awareness Society, Hyd Telangana
2	Project Name	AI Based Line follower Robotic
3	Sponsored by	N.M. ICPS, DST, Govt of India
4	School Name	Govt. PS. Kagaz Nagar.
5	School Address	Vill, Md :- Kagaz Nagar Dist :- Komarambheem (Asif)
6	Signature of School Principal with Stamp	HEADMASTER GovtMPPS School Sipur Kagaznagar Komaram Bheem Asif
7	Mobile Number	9708619733
8	Program Date	27-08-2019
9	Science Model is registered in school science book	Yes/Sign:
10	Feedback demonstration project	Good/Excellent
11	Signature of Project Trainer	AM
12	Signature of Project Investigator	Bellee

SCHOOL AWARENESS PROGRAMS REGISTRATION FOAM

S.No.	Description	Details
1	Organization Name:	MULTIPURPOSE AWARENESS SOCIETY
2	Project Name:	ARTIFICIAL INTELLIGENCE BASED LINE FOLLOWING ROBOTS
3	Theme :	DEMONSTRATION ON MODEL OF LATEST TECHNOLOGY RELEVANT ROBOT AND AI
4	Sponsored by:	DEPARTMENT OF SCIENCE & TECHNOLOGY GOVERNMENT OF INDIA
5	School Name:	MPPS URDU ASIFABAD
6	Address School :	opp Govt Hospital Asifabad
7	Signature of School principal with stamp	HEAD MASTER MPPS Asifabad U/M M.P. Asifabad Dist. Adilabad (TS)
8	Mobile Number	8341290490
9	Date of Program:	27-8-2019
10	Number of Student Participated	42
11	Model is Registered in School Science Book	Yes
12	Feed back of the School Science Teacher /Students	Good/Excellent
13	Signature of Project Trainer	Kalpesh
14	Signature of Project Investigator	Bellee

SCHOOL AWARENESS PROGRAMS REGISTRATION FOAM

S.No.	Description	Details
1	Organization Name:	MULTIPURPOSE AWARENESS SOCIETY
2	Project Name:	ARTIFICIAL INTELLIGENCE BASED LINE FOLLOWING ROBOTS
3	Theme :	DEMONSTRATION ON MODEL OF LATEST TECHNOLOGY RELEVANT ROBOT AND AI
4	Sponsored by:	DEPARTMENT OF SCIENCE & TECHNOLOGY GOVERNMENT OF INDIA
5	School Name:	GOVT Ashram School (Boys) Asifabad.
6	Address School :	Asifabad opp: forest office Komaram bheem Asifabad
7	Signature of School principal with stamp	-
8	Mobile Number	9963622572
9	Date of Program:	27-08-2019
10	Number of Student Participated	30
11	Model is Registered in School Science Book	Yes
12	Feed back of the School Science Teacher /Students	Good/Excellent
13	Signature of Project Trainer	Kalpesh
14	Signature of Project Investigator	Bellee

HEAD MASTER
GA.H.S. (B), Asifabad



**ARTIFICIAL INTELLIGENCE BASED LINE FOLLOWER ROBOT
FOR RURAL SCHOOL STUDENTS IN KOMARAM BHEEM ASIFABAD
DISTRICT, TELANGANA STATE**
PROJECT DEMONSTRATION AND SCHOOL EXPERIMENT ACTIVITIES
Certificates

School Awareness Programs registration

S.No.	Description	Details
1	Organization Name	Multipurpose Awareness Society, Hvd Telangana
2	Project Name	AI Based Line follower Robotic
3	Sponsored by	N.M. ICPS, DST, Govt of India
4	School Name	MPPS - Nandiguda
5	School Address	Vill: Nandiguda, Md1 - Sirpur K28 Dist - Komurambheem (ASF)
6	Signature of School Principal with Stamp	
7	Mobile Number	9805432200
8	Program Date	26-08-2019
9	Science Model is registered in school science book	Yes/Sign:
10	Feedback demonstration project	Good/Excellent
11	Signature of Project Trainer	
12	Signature of Project Investigator	

SCHOOL AWARENESS PROGRAMS REGISTRATION FOAM

S.No.	Description	Details
1	Organization Name	MULTIPURPOSE AWARENESS SOCIETY
2	Project Name	ARTIFICIAL INTELLIGENCE BASED LINE FOLLOWING ROBOTS
3	Theme	DEMONSTRATION ON MODEL OF LATEST TECHNOLOGY RELEVANT ROBOT AND AI
4	Sponsored by	DEPARTMENT OF SCIENCE & TECHNOLOGY GOVERNMENT OF INDIA
5	School Name	MPPS - PETROLPUMP (Word 22)
6	Address School	Vill, Md1 :- Sirpur Kaghanagar Dist :- Komurambheem (ASF)
7	Signature of School principal with stamp	
8	Mobile Number	-
9	Date of Program	26-08-2019
10	Number of Student Participated	63
11	Model is Registered in School Science Book	Yes
12	Feed back of the School Science Teacher / Students	Good/Excellent
13	Signature of Project Trainer	
14	Signature of Project Investigator	

SCHOOL AWARENESS PROGRAMS REGISTRATION FOAM

S.No.	Description	Details
1	Organization Name	MULTIPURPOSE AWARENESS SOCIETY
2	Project Name	ARTIFICIAL INTELLIGENCE BASED LINE FOLLOWING ROBOTS
3	Theme	DEMONSTRATION ON MODEL OF LATEST TECHNOLOGY RELEVANT ROBOT AND AI
4	Sponsored by	DEPARTMENT OF SCIENCE & TECHNOLOGY GOVERNMENT OF INDIA
5	School Name	Vidhyadhasi High School
6	Address School	Binagar Colony, Kaghanagar
7	Signature of School principal with stamp	
8	Mobile Number	-
9	Date of Program	26/8/19
10	Number of Student Participated	12
11	Model is Registered in School Science Book	Yes
12	Feed back of the School Science Teacher / Students	Good/Excellent
13	Signature of Project Trainer	
14	Signature of Project Investigator	

SCHOOL AWARENESS PROGRAMS REGISTRATION FOAM

S.No.	Description	Details
1	Organization Name	MULTIPURPOSE AWARENESS SOCIETY
2	Project Name	ARTIFICIAL INTELLIGENCE BASED LINE FOLLOWING ROBOTS
3	Theme	DEMONSTRATION ON MODEL OF LATEST TECHNOLOGY RELEVANT ROBOT AND AI
4	Sponsored by	DEPARTMENT OF SCIENCE & TECHNOLOGY GOVERNMENT OF INDIA
5	School Name	mpps word No. 5
6	Address School	Vill, Md1:- Sirpur (K28) Dist :- Komurambheem (ASF)
7	Signature of School principal with stamp	
8	Mobile Number	-
9	Date of Program	26-08-2019
10	Number of Student Participated	36
11	Model is Registered in School Science Book	Yes
12	Feed back of the School Science Teacher / Students	Good/Excellent
13	Signature of Project Trainer	
14	Signature of Project Investigator	



ARTIFICIAL INTELLIGENCE BASED LINE FOLLOWER ROBOT FOR RURAL SCHOOL STUDENTS IN KOMARAM BHEEM ASIFABAD DISTRICT, TELANGANA STATE
PROJECT DEMONSTRATION AND SCHOOL EXPERIMENT ACTIVITIES
Certificates

P-90

School Awareness Programs registration

S.No.	Description	Details
1	Organization Name	Multipurpose Awareness Society, Hyd Telangana
2	Project Name	AI Based Line follower Robotic
3	Sponsored by	N.M. ICPS, DST, Govt of India
4	School Name	Govt. MPPS Hanjanvada
5	School Address	Vill Hanjanvada, Md. Sripur (K2R) Dist: Komurambheem (ASF)
6	Signature of School Principal with Stamp	
7	Mobile Number	8619738489
8	Program Date	23-08-2019
9	Science Model is registered in school science book	Yes/Sign:
10	Feedback demonstration project	Good/Excellent
11	Signature of Project Trainer	
12	Signature of Project Investigator	

P-91

SCHOOL AWARENESS PROGRAM REGISTRATION FORM

S.No.	Description	Details
1	Organization Name	MULTIPURPOSE AWARENESS SOCIETY
2	Project Name	ARTIFICIAL INTELLIGENCE BASED LINE FOLLOWING ROBOTS
3	Theme	DEMONSTRATION ON MODEL OF LATEST TECHNOLOGY RELEVANT ROBOT AND AI
4	Sponsored by	DEPARTMENT OF SCIENCE & TECHNOLOGY GOVERNMENT OF INDIA
5	School Name	Govt. PS. OLD (ERO Colony)
6	Address of school	Vill. ERO Colony, Md. Sipur (K2R) Dist: Komurambheem (ASF)
7	Signature of School principal with stamp	
8	Mobile Number	9703542139
9	Date of Program	23-08-2019
10	Number of Students Participated	41
11	Model is Registered in school science book	Yes
12	Feedback of the School Project Teacher/Students	Good/Excellent
13	Signature of Project Trainer	
14	Signature of Project Investigator	

P-92

School Awareness Programs registration

S.No.	Description	Details
1	Organization Name	Multipurpose Awareness Society, Hyd Telangana
2	Project Name	AI Based Line follower Robotic
3	Sponsored by	N.M. ICPS, DST, Govt of India
4	School Name	MPPS. KAPUNADA
5	School Address	Vill, Md: Sipur (K2R) Dist: Komurambheem (ASF)
6	Signature of School Principal with Stamp	
7	Mobile Number	7913388743
8	Program Date	23-08-2019
9	Science Model is registered in school science book	Yes/Sign:
10	Feedback demonstration project	Good/Excellent
11	Signature of Project Trainer	
12	Signature of Project Investigator	

P-93

School Awareness Programs registration

S.No.	Description	Details
1	Organization Name	Multipurpose Awareness Society, Hyd Telangana
2	Project Name	AI Based Line follower Robotic
3	Sponsored by	N.M. ICPS, DST, Govt of India
4	School Name	Govt. UPS. WORD No. 14 (K2R)
5	School Address	Sipur Kagaz Nagar, Dist. Komurambheem (ASF)
6	Signature of School Principal with Stamp	
7	Mobile Number	9979361970
8	Program Date	26-08-2019
9	Science Model is registered in school science book	Yes/Sign:
10	Feedback demonstration project	Good/Excellent
11	Signature of Project Trainer	
12	Signature of Project Investigator	



ARTIFICIAL INTELLIGENCE BASED LINE FOLLOWER ROBOT FOR RURAL SCHOOL STUDENTS IN KOMARAM BHEEM ASIFABAD DISTRICT, TELANGANA STATE
PROJECT DEMONSTRATION AND SCHOOL EXPERIMENT ACTIVITIES
Certificates

P-66

SCHOOL AWARENESS PROGRAMS REGISTRATION FOAM

S.No.	Description	Details
1	Organization Name:	MULTIPURPOSE AWARENESS SOCIETY
2	Project Name:	ARTIFICIAL INTELLIGENCE BASED LINE FOLLOWING ROBOTS
3	Theme :	DEMONSTRATION ON MODEL OF LATEST TECHNOLOGY RELEVANT ROBOT AND AI
4	Sponsored by:	DEPARTMENT OF SCIENCE & TECHNOLOGY GOVERNMENT OF INDIA
5	School Name:	Chaitanya Vidya Mandir
6	Address School:	Chinthaguda (U) KZR M: KZR. Dist: Komarambheem
7	Signature of School principal with stamp	 Headmaster Chaitanya Vidya Mandir E/M & TM Chinthaguda (K), M&K, Kaghaznagar Dist. Komaram Bheem Asifabad
8	Mobile Number :	9948097232
9	Date of Program:	21-08-2019
10	Number of Student Participated	30
11	Model is Registered in School Science Book	Yes
12	Feed back of the School Science Teacher /Students	Good/Excellent
13	Signature of Project Trainer	NM
14	Signature of Project Investigator	BWJ

P-67

SCHOOL AWARENESS PROGRAMS REGISTRATION FOAM

S.No.	Description	Details
1	Organization Name:	MULTIPURPOSE AWARENESS SOCIETY
2	Project Name:	ARTIFICIAL INTELLIGENCE BASED LINE FOLLOWING ROBOTS
3	Theme :	DEMONSTRATION ON MODEL OF LATEST TECHNOLOGY RELEVANT ROBOT AND AI
4	Sponsored by:	DEPARTMENT OF SCIENCE & TECHNOLOGY GOVERNMENT OF INDIA
5	School Name:	Sree Vishwa Shanti Nani High School Patrol Pump, Kaghaznagar K.B. Amb. S. 504296
6	Address School:	Sree Vishwa Shanti High School E.M. Patrolpump, Kaghaznagar, Dist. Komarambheem Asifabad.
7	Signature of School principal with stamp	 Headmaster Sree Vishwa Shanti High School Patrol Pump, Kaghaznagar Dist. Komaram Bheem Asif.
8	Mobile Number :	964045074
9	Date of Program:	22-08-2019
10	Number of Student Participated	100 students
11	Model is Registered in School Science Book	Yes
12	Feed back of the School Science Teacher /Students	Good/Excellent
13	Signature of Project Trainer	NM
14	Signature of Project Investigator	BWJ

P-68

School Awareness Programs registration

S.No.	Description	Details
1	Organization Name	Multipurpose Awareness Society, Hyd Telangana
2	Project Name	AI Based Line follower Robotic
3	Sponsored by	N.M. ICPS, DST, Govt of India
4	School Name	Mpps Wood No: 13 Kagaznagar
5	School Address	Sispu Kagaznagar (Komarambheem)
6	Signature of School Principal with Stamp	 HEADMASTER Govt MPPS School Sispu, Kaghaznagar Dist. Komaram Bheem Asif.
7	Mobile Number	88066131619
8	Program Date	23-08-2019
9	Science Model is registered in school science book	Yes/Sign:
10	Feedback demonstration project	Good/Excellent
11	Signature of Project Trainer	NM
12	Signature of Project Investigator	BWJ

P-69

SCHOOL AWARENESS PROGRAMS REGISTRATION FOAM

S.No.	Description	Details
1	Organization Name:	MULTIPURPOSE AWARENESS SOCIETY
2	Project Name:	ARTIFICIAL INTELLIGENCE BASED LINE FOLLOWING ROBOTS
3	Theme :	DEMONSTRATION ON MODEL OF LATEST TECHNOLOGY RELEVANT ROBOT AND AI
4	Sponsored by:	DEPARTMENT OF SCIENCE & TECHNOLOGY GOVERNMENT OF INDIA
5	School Name:	Govt. P.S. Gangaram basti
6	Address School:	Vill, Moll - Sispu Kagaznagar, Dist - Komarambheem (ASIF)
7	Signature of School principal with stamp	 HEADMASTER Govt P.S. School Sispu, Kaghaznagar Dist. Komaram Bheem Asif.
8	Mobile number:	
9	Date of Program:	23-08-2019
10	Number of Student Participated	36
11	Model is Registered in School Science Book	Yes
12	Feed back of the School Science Teacher /Students	Good/Excellent
13	Signature of Project Trainer	NM
14	Signature of Project Investigator	BWJ



ARTIFICIAL INTELLIGENCE BASED LINE FOLLOWER ROBOT FOR RURAL SCHOOL STUDENTS IN KOMARAM BHEEM ASIFABAD DISTRICT, TELANGANA STATE
PROJECT DEMONSTRATION AND SCHOOL EXPERIMENT ACTIVITIES
Certificates

P-82

S.No.	Description	Details
1	Organization Name:	MULTIPURPOSE AWARENESS SOCIETY
2	Project Name:	ARTIFICIAL INTELLIGENCE BASED LINE FOLLOWING ROBOTS
3	Theme :	DEMONSTRATION ON MODEL OF LATEST TECHNOLOGY RELEVANT ROBOT AND AI
4	Sponsored by:	DEPARTMENT OF SCIENCE & TECHNOLOGY GOVERNMENT OF INDIA
5	School Name:	Sree Vani Vidyalayam.
6	Address School :	Village: Chintaguda @ Mondel. Kaghaznagar Dist. Kumarambheem (ASF)
7	Signature of School principal with stamp	
8	Mobile Number :	9701821846.
9	Date of Program:	21/08/2019.
10	Number of Student Participated	30 students.
11	Model is Registered in School Science Book	Yes.
12	Feed back of the School Science Teacher /Students	Good/Excellent
13	Signature of Project Trainer	
14	Signature of Project Investigator	

P-83

S.No.	Description	Details
1	Organization Name:	MULTIPURPOSE AWARENESS SOCIETY
2	Project Name:	ARTIFICIAL INTELLIGENCE BASED LINE FOLLOWING ROBOTS
3	Theme :	DEMONSTRATION ON MODEL OF LATEST TECHNOLOGY RELEVANT ROBOT AND AI
4	Sponsored by:	DEPARTMENT OF SCIENCE & TECHNOLOGY GOVERNMENT OF INDIA
5	School Name:	M.P.P.S (URDU) F. QUARTER KOYAVAGU KASHANAGAR SOYAL DIST. KOMARAM BHEEM ASIFABAD
6	Address School :	M.P.P.S (URDU) F. QUARTER KOYAVAGU KASHANAGAR SOYAL DIST. KOMARAM BHEEM ASIFABAD
7	Signature of School principal with stamp	
8	Mobile Number :	8998125895 9490139462
9	Date of Program:	21-08-2019
10	Number of Student Participated	35
11	Model is Registered in School Science Book	YES
12	Feed back of the School Science Teacher /Students	Good/Excellent
13	Signature of Project Trainer	
14	Signature of Project Investigator	

MUNAWAR Ahmed 2018 B@gmail.com

P-84

S.No.	Description	Details
1	Organization Name:	MULTIPURPOSE AWARENESS SOCIETY
2	Project Name:	ARTIFICIAL INTELLIGENCE BASED LINE FOLLOWING ROBOTS
3	Theme :	DEMONSTRATION ON MODEL OF LATEST TECHNOLOGY RELEVANT ROBOT AND AI
4	Sponsored by:	DEPARTMENT OF SCIENCE & TECHNOLOGY GOVERNMENT OF INDIA
5	School Name:	M.P.P.S. Girls Asifabad.
6	Address School :	Near bus stand. K.B. Asifabad.
7	Signature of School principal with stamp	
8	Mobile Number :	9403272010
9	Date of Program:	21-08-2019
10	Number of Student Participated	50
11	Model is Registered in School Science Book	Yes.
12	Feed back of the School Science Teacher /Students	Good/Excellent
13	Signature of Project Trainer	
14	Signature of Project Investigator	

P-85

S.No.	Description	Details
1	Organization Name:	MULTIPURPOSE AWARENESS SOCIETY
2	Project Name:	ARTIFICIAL INTELLIGENCE BASED LINE FOLLOWING ROBOTS
3	Theme :	DEMONSTRATION ON MODEL OF LATEST TECHNOLOGY RELEVANT ROBOT AND AI
4	Sponsored by:	DEPARTMENT OF SCIENCE & TECHNOLOGY GOVERNMENT OF INDIA
5	School Name:	Mc Guffey E/M (School)
6	Address School :	3-6-1, Singilk chowk Kaghaz Nagar
7	Signature of School principal with stamp	
8	Mobile Number :	9440372
9	Date of Program:	21-08-19
10	Number of Student Participated	100
11	Model is Registered in School Science Book	YES
12	Feed back of the School Science Teacher /Students	Good/Excellent
13	Signature of Project Trainer	
14	Signature of Project Investigator	

PRINCIPAL
McGuffey International School
Singilk Chowk, Kaghaznagar,
Dist. Kumarambheem Asif.



ARTIFICIAL INTELLIGENCE BASED LINE FOLLOWER ROBOT FOR RURAL SCHOOL STUDENTS IN KOMARAM BHEEM ASIFABAD DISTRICT, TELANGANA STATE
PROJECT DEMONSTRATION AND SCHOOL EXPERIMENT ACTIVITIES
Certificates

P-118

SCHOOL AWARENESS PROGRAMS REGISTRATION FOAM

S.No.	Description	Details
1	Organization Name:	MULTIPURPOSE AWARENESS SOCIETY
2	Project Name:	ARTIFICIAL INTELLIGENCE BASED LINE FOLLOWING ROBOTS
3	Theme :	DEMONSTRATION ON MODEL OF LATEST TECHNOLOGY RELEVANT ROBOT AND AI
4	Sponsored by:	DEPARTMENT OF SCIENCE & TECHNOLOGY GOVERNMENT OF INDIA
5	School Name:	Mpps Balagala
6	Address School :	Sirpur Kaganagar Komuzambheem (Asf)
7	Signature of School principal with stamp	
8	Mobile Number :	—
9	Date of Program:	29-08-2019
10	Number of Student Participated	28
11	Model is Registered in School Science Book	Yes
12	Feed back of the School Science Teacher /Students	Good/Excellent
13	Signature of Project Trainer	Nmi
14	Signature of Project Investigator	Bellef

P-119

SCHOOL AWARENESS PROGRAMS REGISTRATION FOAM

S.No.	Description	Details
1	Organization Name:	MULTIPURPOSE AWARENESS SOCIETY
2	Project Name:	ARTIFICIAL INTELLIGENCE BASED LINE FOLLOWING ROBOTS
3	Theme :	DEMONSTRATION ON MODEL OF LATEST TECHNOLOGY RELEVANT ROBOT AND AI
4	Sponsored by:	DEPARTMENT OF SCIENCE & TECHNOLOGY GOVERNMENT OF INDIA
5	School Name:	Mpps. Durgach Wada.
6	Address School :	Vill. Durgach Wada. Mdl. Sirpur (Kze) Kaganagar Dist: Komurambheem (Asf)
7	Signature of School principal with stamp	
8	Mobile Number :	791633197
9	Date of Program:	29-08-2019
10	Number of Student Participated	24
11	Model is Registered in School Science Book	Yes
12	Feed back of the School Science Teacher /Students	Good/Excellent
13	Signature of Project Trainer	Nmi
14	Signature of Project Investigator	Bellef

P-120

SCHOOL AWARENESS PROGRAMS REGISTRATION FOAM

S.No.	Description	Details
1	Organization Name:	MULTIPURPOSE AWARENESS SOCIETY
2	Project Name:	ARTIFICIAL INTELLIGENCE BASED LINE FOLLOWING ROBOTS
3	Theme :	DEMONSTRATION ON MODEL OF LATEST TECHNOLOGY RELEVANT ROBOT AND AI
4	Sponsored by:	DEPARTMENT OF SCIENCE & TECHNOLOGY GOVERNMENT OF INDIA
5	School Name:	MPPS. AREGUDA (A)
6	Address School :	Vill. Areguda Mdl. Sirpur (Kze) Dist. Komurambheem (Asf)
7	Signature of School principal with stamp	
8	Mobile Number :	7013986139
9	Date of Program:	29-08-2019
10	Number of Student Participated	28
11	Model is Registered in School Science Book	Yes
12	Feed back of the School Science Teacher /Students	Good/Excellent
13	Signature of Project Trainer	Nmi
14	Signature of Project Investigator	Bellef

P-121

SCHOOL AWARENESS PROGRAMS REGISTRATION FOAM

S.No.	Description	Details
1	Organization Name:	MULTIPURPOSE AWARENESS SOCIETY
2	Project Name:	ARTIFICIAL INTELLIGENCE BASED LINE FOLLOWING ROBOTS
3	Theme :	DEMONSTRATION ON MODEL OF LATEST TECHNOLOGY RELEVANT ROBOT AND AI
4	Sponsored by:	DEPARTMENT OF SCIENCE & TECHNOLOGY GOVERNMENT OF INDIA
5	School Name:	Mpps Bareguda.
6	Address School :	Sirpur Kaganagar Komuzambheem (Asf)
7	Signature of School principal with stamp	
8	Mobile Number :	—
9	Date of Program:	29-08-2019
10	Number of Student Participated	35
11	Model is Registered in School Science Book	Yes
12	Feed back of the School Science Teacher /Students	Good/Excellent
13	Signature of Project Trainer	Nmi
14	Signature of Project Investigator	Bellef



**ARTIFICIAL INTELLIGENCE BASED LINE FOLLOWER ROBOT
FOR RURAL SCHOOL STUDENTS IN KOMARAM BHEEM ASIFABAD
DISTRICT, TELANGANA STATE**
PROJECT DEMONSTRATION AND SCHOOL EXPERIMENT ACTIVITIES
Certificates

P-110

S.No.	Description	Details
1	Organization Name:	MULTIPURPOSE AWARENESS SOCIETY
2	Project Name:	ARTIFICIAL INTELLIGENCE BASED LINE FOLLOWING ROBOTS
3	Theme :	DEMONSTRATION ON MODEL OF LATEST TECHNOLOGY RELEVANT ROBOT AND AI
4	Sponsored by:	DEPARTMENT OF SCIENCE & TECHNOLOGY GOVERNMENT OF INDIA
5	School Name:	MPPS Sampet U/M
6	Address School :	Sirpur - T
7	Signature of School principal with stamp	
8	Mobile Number :	
9	Date of Program:	28/08/2019
10	Number of Student Participated	
11	Model is Registered in School Science Book	78
12	Feed back of the School Science Teacher /Students	Good/Excellent
13	Signature of Project Trainer	K. Anand
14	Signature of Project Investigator	Beej

P-111

S.No.	Description	Details
1	Organization Name:	MULTIPURPOSE AWARENESS SOCIETY
2	Project Name:	ARTIFICIAL INTELLIGENCE BASED LINE FOLLOWING ROBOTS
3	Theme :	DEMONSTRATION ON MODEL OF LATEST TECHNOLOGY RELEVANT ROBOT AND AI
4	Sponsored by:	DEPARTMENT OF SCIENCE & TECHNOLOGY GOVERNMENT OF INDIA
5	School Name:	Govt. Ashram High School (Girls)
6	Address School :	Govt. A.H.S (G), Sirpur(T), Kumram Bheem Asifabad (Dist)
7	Signature of School principal with stamp	
8	Mobile Number :	9440233630
9	Date of Program:	28/08/2019
10	Number of Student Participated	382
11	Model is Registered in School Science Book	Yes
12	Feed back of the School Science Teacher /Students	Good/Excellent
13	Signature of Project Trainer	K. Anand
14	Signature of Project Investigator	Beej

P-112

S.No.	Description	Details
1	Organization Name:	MULTIPURPOSE AWARENESS SOCIETY
2	Project Name:	ARTIFICIAL INTELLIGENCE BASED LINE FOLLOWING ROBOTS
3	Theme :	DEMONSTRATION ON MODEL OF LATEST TECHNOLOGY RELEVANT ROBOT AND AI
4	Sponsored by:	DEPARTMENT OF SCIENCE & TECHNOLOGY GOVERNMENT OF INDIA
5	School Name:	MPPS. Wallakonda
6	Address School :	VIII. Wallakonda, Mdl. Sirpur Kagan Nugar Dist. Komaram Bheem (ASF)
7	Signature of School principal with stamp	
8	Mobile Number :	9705613913
9	Date of Program:	29-08-2019
10	Number of Student Participated	32
11	Model is Registered in School Science Book	Yes
12	Feed back of the School Science Teacher /Students	Good/Excellent
13	Signature of Project Trainer	K. Anand
14	Signature of Project Investigator	Beej

P-113

S.No.	Description	Details
1	Organization Name:	MULTIPURPOSE AWARENESS SOCIETY
2	Project Name:	ARTIFICIAL INTELLIGENCE BASED LINE FOLLOWING ROBOTS
3	Theme :	DEMONSTRATION ON MODEL OF LATEST TECHNOLOGY RELEVANT ROBOT AND AI
4	Sponsored by:	DEPARTMENT OF SCIENCE & TECHNOLOGY GOVERNMENT OF INDIA
5	School Name:	Mpps Gandhinagar
6	Address School :	Gandhinagar, Sirpur Kagan Nagar (Komaram Bheem)
7	Signature of School principal with stamp	
8	Mobile Number :	
9	Date of Program:	29-08-2019
10	Number of Student Participated	26
11	Model is Registered in School Science Book	Yes
12	Feed back of the School Science Teacher /Students	Good/Excellent
13	Signature of Project Trainer	K. Anand
14	Signature of Project Investigator	Beej



ARTIFICIAL INTELLIGENCE BASED LINE FOLLOWER ROBOT FOR RURAL SCHOOL STUDENTS IN KOMARAM BHEEM ASIFABAD DISTRICT, TELANGANA STATE
PROJECT DEMONSTRATION AND SCHOOL EXPERIMENT ACTIVITIES
Certificates

P-114

S.No.	Description	Details
1	Organization Name:	MULTIPURPOSE AWARENESS SOCIETY
2	Project Name:	ARTIFICIAL INTELLIGENCE BASED LINE FOLLOWING ROBOTS
3	Theme :	DEMONSTRATION ON MODEL OF LATEST TECHNOLOGY RELEVANT ROBOT AND AI
4	Sponsored by:	DEPARTMENT OF SCIENCE & TECHNOLOGY GOVERNMENT OF INDIA
5	School Name:	MPPS. Gollaguda.
6	Address School :	Vill: Gollaguda, Mdl. Sirpur (Kazr) Dist: Komurambheem (Asf)
7	Signature of School principal with stamp	
8	Mobile Number :	9705631388
9	Date of Program:	29-08-2019
10	Number of Student Participated	25
11	Model is Registered in School Science Book	Yes
12	Feed back of the School Science Teacher /Students	Good/Excellent
13	Signature of Project Trainer	Nmi
14	Signature of Project Investigator	Beleef

P-115

S.No.	Description	Details
1	Organization Name:	MULTIPURPOSE AWARENESS SOCIETY
2	Project Name:	ARTIFICIAL INTELLIGENCE BASED LINE FOLLOWING ROBOTS
3	Theme :	DEMONSTRATION ON MODEL OF LATEST TECHNOLOGY RELEVANT ROBOT AND AI
4	Sponsored by:	DEPARTMENT OF SCIENCE & TECHNOLOGY GOVERNMENT OF INDIA
5	School Name:	MPPS. Gannabam.
6	Address School :	Vill. Gannabam. Mdl. Sirpur Kagan Nagar Dist. Komurambheem (Asf)
7	Signature of School principal with stamp	
8	Mobile Number :	9573615201
9	Date of Program:	29-08-2019
10	Number of Student Participated	25
11	Model is Registered in School Science Book	Yes
12	Feed back of the School Science Teacher /Students	Good/Excellent
13	Signature of Project Trainer	Nmi
14	Signature of Project Investigator	Beleef

P-116

S.No.	Description	Details
1	Organization Name:	MULTIPURPOSE AWARENESS SOCIETY
2	Project Name:	ARTIFICIAL INTELLIGENCE BASED LINE FOLLOWING ROBOTS
3	Theme :	DEMONSTRATION ON MODEL OF LATEST TECHNOLOGY RELEVANT ROBOT AND AI
4	Sponsored by:	DEPARTMENT OF SCIENCE & TECHNOLOGY GOVERNMENT OF INDIA
5	School Name:	MPPS. Mala seetha nagar.
6	Address School :	Vill. Mala Seetha Nagar. Mdl:- Sirpur Kagan Nagar Dist:- Komurambheem (Asf)
7	Signature of School principal with stamp	
8	Mobile Number :	9623194550
9	Date of Program:	29-08-2019
10	Number of Student Participated	26
11	Model is Registered in School Science Book	Yes
12	Feed back of the School Science Teacher /Students	Good/Excellent
13	Signature of Project Trainer	Nmi
14	Signature of Project Investigator	Beleef

P-117

S.No.	Description	Details
1	Organization Name:	MULTIPURPOSE AWARENESS SOCIETY
2	Project Name:	ARTIFICIAL INTELLIGENCE BASED LINE FOLLOWING ROBOTS
3	Theme :	DEMONSTRATION ON MODEL OF LATEST TECHNOLOGY RELEVANT ROBOT AND AI
4	Sponsored by:	DEPARTMENT OF SCIENCE & TECHNOLOGY GOVERNMENT OF INDIA
5	School Name:	MPPS. Shivapur
6	Address School :	Vill. Shivapur Mdl. Sirpur Kagan Nagar Dist:- Komurambheem (Asf)
7	Signature of School principal with stamp	
8	Mobile Number :	-
9	Date of Program:	29-08-2019
10	Number of Student Participated	39
11	Model is Registered in School Science Book	Yes
12	Feed back of the School Science Teacher /Students	Good/Excellent
13	Signature of Project Trainer	Nmi
14	Signature of Project Investigator	Beleef



**ARTIFICIAL INTELLIGENCE BASED LINE FOLLOWER ROBOT
FOR RURAL SCHOOL STUDENTS IN KOMARAM BHEEM ASIFABAD
DISTRICT, TELANGANA STATE**
PROJECT DEMONSTRATION AND SCHOOL EXPERIMENT ACTIVITIES
Certificates

P-79

SCHOOL AWARENESS PROGRAM'S REGISTRATION FOAM

S.No.	Description	Details
1	Organization Name:	MULTIPURPOSE AWARENESS SOCIETY
2	Project Name:	ARTIFICIAL INTELLIGENCE BASED LINE FOLLOWING ROBOTS
3	Theme :	DEMONSTRATION ON MODEL OF LATEST TECHNOLOGY RELEVANT ROBOT AND AI
4	Sponsored by:	DEPARTMENT OF SCIENCE & TECHNOLOGY GOVERNMENT OF INDIA
5	School Name:	Shishu Mandir High School
6	Address School :	Shishu Mandir High School Sir Silk colony Kaghnagar 504296
7	Signature of School principal with stamp	
8	Mobile Number :	9014958061
9	Date of Program:	20/08/2019
10	Number of Student Participated	90
11	Model is Registered in School Science Book	yes
12	Feed back of the School Science Teacher /Students	Good/Excellent
13	Signature of Project Trainer	
14	Signature of Project Investigator	

P-90

SCHOOL AWARENESS PROGRAM'S REGISTRATION FOAM

S.No.	Description	Details
1	Organization Name:	MULTIPURPOSE AWARENESS SOCIETY
2	Project Name:	ARTIFICIAL INTELLIGENCE BASED LINE FOLLOWING ROBOTS
3	Theme :	DEMONSTRATION ON MODEL OF LATEST TECHNOLOGY RELEVANT ROBOT AND AI
4	Sponsored by:	DEPARTMENT OF SCIENCE & TECHNOLOGY GOVERNMENT OF INDIA
5	School Name:	Govt primary RB urdu
6	Address School :	LBs market Sirsilk colony, SKR K.B. Asifabad, T.S.
7	Signature of School principal with stamp	
8	Mobile Number :	9347376966
9	Date of Program:	20-08-2019
10	Number of Student Participated	35
11	Model is Registered in School Science Book	yes
12	Feed back of the School Science Teacher /Students	Good/Excellent
13	Signature of Project Trainer	
14	Signature of Project Investigator	



P-61

SCHOOL AWARENESS PROGRAM'S REGISTRATION FOAM

S.No.	Description	Details
1	Organization Name:	MULTIPURPOSE AWARENESS SOCIETY
2	Project Name:	ARTIFICIAL INTELLIGENCE BASED LINE FOLLOWING ROBOTS
3	Theme :	DEMONSTRATION ON MODEL OF LATEST TECHNOLOGY RELEVANT ROBOT AND AI
4	Sponsored by:	DEPARTMENT OF SCIENCE & TECHNOLOGY GOVERNMENT OF INDIA
5	School Name:	Govt High School RB Urdu Kaghnagar
6	Address School :	Sirsilk Colony Main No: 3 Sirpur Kaghnagar Dist: KB Asifabad
7	Signature of School principal with stamp	
8	Mobile Number :	9440130071
9	Date of Program:	20-08-2019
10	Number of Student Participated	21
11	Model is Registered in School Science Book	- Yes -
12	Feed back of the School Science Teacher /Students	Good/Excellent
13	Signature of Project Trainer	
14	Signature of Project Investigator	





**ARTIFICIAL INTELLIGENCE BASED LINE FOLLOWER ROBOT
FOR RURAL SCHOOL STUDENTS IN KOMARAM BHEEM ASIFABAD
DISTRICT, TELANGANA STATE**
PROJECT DEMONSTRATION AND SCHOOL EXPERIMENT ACTIVITIES PHOTOS





**ARTIFICIAL INTELLIGENCE BASED LINE FOLLOWER ROBOT
FOR RURAL SCHOOL STUDENTS IN KOMARAM BHEEM ASIFABAD
DISTRICT, TELANGANA STATE**
PROJECT DEMONSTRATION AND SCHOOL EXPERIMENT ACTIVITIES PHOTOS





**ARTIFICIAL INTELLIGENCE BASED LINE FOLLOWER ROBOT
FOR RURAL SCHOOL STUDENTS IN KOMARAM BHEEM ASIFABAD
DISTRICT, TELANGANA STATE**
PROJECT DEMONSTRATION AND SCHOOL EXPERIMENT ACTIVITIES PHOTOS





**ARTIFICIAL INTELLIGENCE BASED LINE FOLLOWER ROBOT
FOR RURAL SCHOOL STUDENTS IN KOMARAM BHEEM ASIFABAD
DISTRICT, TELANGANA STATE**
PROJECT DEMONSTRATION AND SCHOOL EXPERIMENT ACTIVITIES PHOTOS





**ARTIFICIAL INTELLIGENCE BASED LINE FOLLOWER ROBOT
FOR RURAL SCHOOL STUDENTS IN KOMARAM BHEEM ASIFABAD
DISTRICT, TELANGANA STATE**
PROJECT DEMONSTRATION AND SCHOOL EXPERIMENT ACTIVITIES PHOTOS





**ARTIFICIAL INTELLIGENCE BASED LINE FOLLOWER ROBOT
FOR RURAL SCHOOL STUDENTS IN KOMARAM BHEEM ASIFABAD
DISTRICT, TELANGANA STATE**
PROJECT DEMONSTRATION AND SCHOOL EXPERIMENT ACTIVITIES PHOTOS





**ARTIFICIAL INTELLIGENCE BASED LINE FOLLOWER ROBOT
FOR RURAL SCHOOL STUDENTS IN KOMARAM BHEEM ASIFABAD
DISTRICT, TELANGANA STATE**
PROJECT DEMONSTRATION AND SCHOOL EXPERIMENT ACTIVITIES PHOTOS





**ARTIFICIAL INTELLIGENCE BASED LINE FOLLOWER ROBOT
FOR RURAL SCHOOL STUDENTS IN KOMARAM BHEEM ASIFABAD
DISTRICT, TELANGANA STATE**
PROJECT DEMONSTRATION AND SCHOOL EXPERIMENT ACTIVITIES PHOTOS

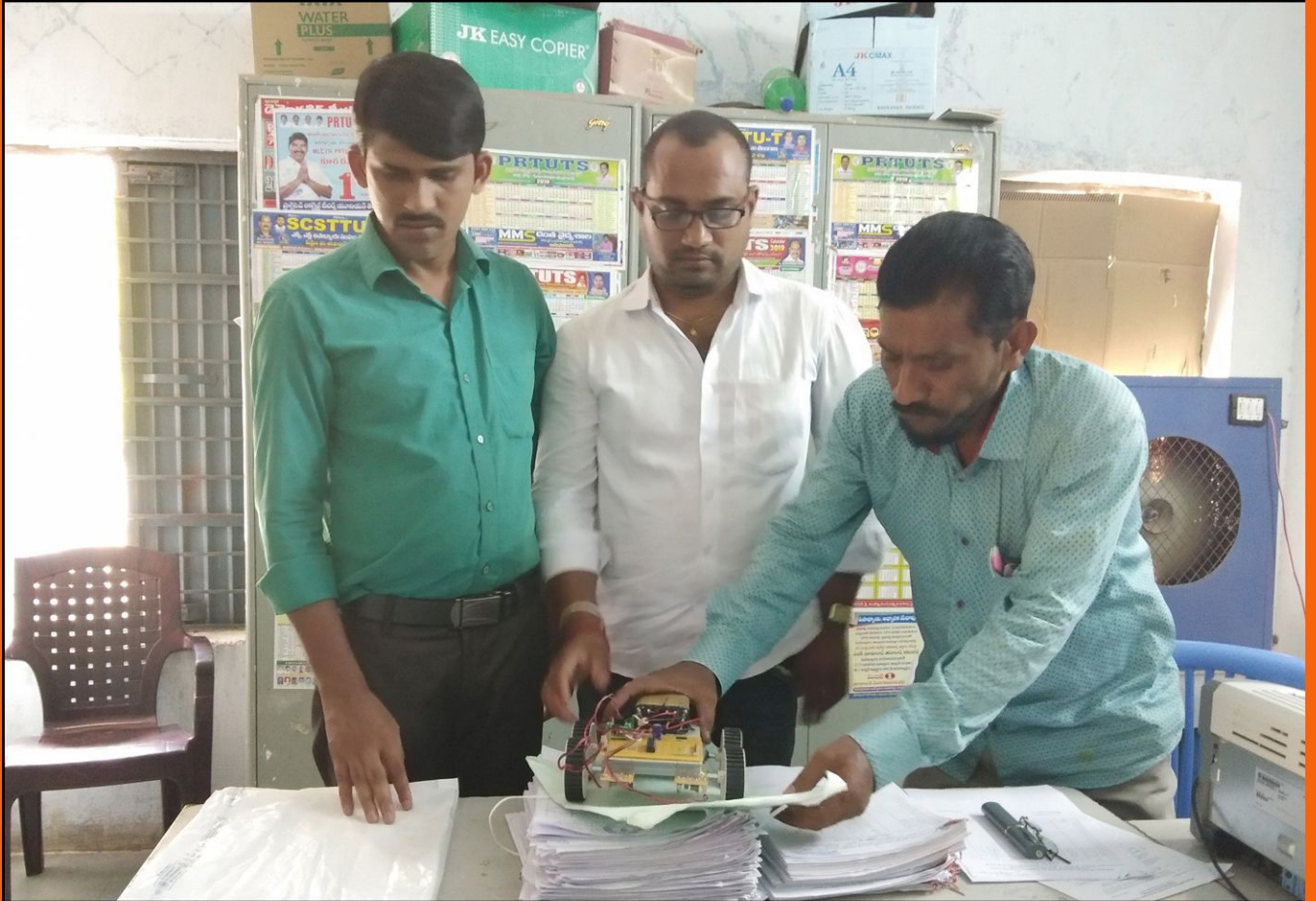



జూనియర్ కాలేజీలో రోబోటిక్స్ వర్క్ షాప్

కాగజీనగర్, వెలుగు:

స్టూడెంట్స్ శాస్త్ర సాంకేతిక పరిజ్ఞానాన్ని విస్తృతంగా వినియోగించుకొని కొత్త విషయాలను కనిపెట్టాలని మల్టీ పర్పస్ అవేర్నెస్ సొసైటీ (హైదరాబాద్) ప్రాజెక్టు ఇన్స్ట్రక్టర్ నాగేశ్వర్ రావు అన్నారు. కేంద్ర శాస్త్ర సాంకేతిక శాఖ అధ్వర్యంలో ఏర్పాటు చేసిన కార్యక్రమంలో భాగంగా మారుమూల ప్రాంతాల్లోని స్టూడెంట్స్ కు శాస్త్ర సాంకేతికతపై అవగాహనలో భాగంగా గురువారం కౌటాల గవర్నమెంట్ జూనియర్ కాలేజీలో స్టూడెంట్స్ కు లైన్ ఫాలోయింగ్ రోబోటిక్స్ వర్క్ షాప్ ఇంటిజెన్సీ అవేర్నెస్ కార్యక్రమాన్ని నిర్వహించారు. ఈ సందర్భంగా హాజరైన స్టూడెంట్స్ కు కంప్యూటర్ రోబో పరిజ్ఞానం వివరించి కొత్త విషయాలు నేర్చుకోవాలని సూచించారు. ఈ సందర్భంగా నాగేశ్వర్ రావు మాట్లాడుతూ కౌటాల బెజ్జూర్, సిర్పూర్, పెంచికలపేట, చిం



స్టూడెంట్స్ కు రోబోటిక్స్ పై వివరిస్తున్న నిర్వాహకులు

తలమానపల్లి మండలాల్లో గిరిజన స్టూడెంట్స్ , ఇతర స్టూడెంట్స్ కు గవర్నమెంట్ స్కూళ్లలో ప్రత్యేక అవగాహన కార్యక్రమాలు జూన్, జులై ఆగస్టులో నిర్వహిస్తామని దీనికి సంబంధించి

యాక్షన్ ప్లాన్ తయారు చేస్తున్నట్లు పేర్కొన్నారు. కార్యక్రమంలో ప్రాజెక్టు ట్రైనర్ సాగర్, ప్రొగ్రాం సూపర్ వైజర్ రాచకొండ రాజు తదితరులు పాల్గొన్నారు.





**ARTIFICIAL INTELLIGENCE BASED LINE FOLLOWER ROBOT
FOR RURAL SCHOOL STUDENTS IN KOMARAM BHEEM ASIFABAD
DISTRICT, TELANGANA STATE**
PROJECT DEMONSTRATION AND SCHOOL EXPERIMENT ACTIVITIES PHOTOS





**ARTIFICIAL INTELLIGENCE BASED LINE FOLLOWER ROBOT
FOR RURAL SCHOOL STUDENTS IN KOMARAM BHEEM ASIFABAD
DISTRICT, TELANGANA STATE**
PROJECT DEMONSTRATION AND SCHOOL EXPERIMENT ACTIVITIES

Certificate



Attendance Sheet for teachers on AI Based Line Follower Robot Training.

S.No	Name of Teacher	School Name	Mobile No	No of kits received	Signature	Feedback
1	V. Padmalaja Parthi	ZPSS (G) Sirsilk	8179420770	1	V.P. Parthi	
2	R. Neeharaja	ZPSS (G) Sirsilk	9948497265	1	[Signature]	Very interesting
3	D. Laxmi Prasanna	H.G.B.V., Raghunadapur	7702201031	1	[Signature]	Robo estavudu kani avudu kani avudu avudu.
4	A. SUNEETHA	ZPSS (G) Sirsilk	9963199721	1	[Signature]	manual kani avudu kani avudu.
5	B. Padmavathi	ZPSS (Boys) Kaganaganur	9849385927	1	[Signature]	Very useful for students
6	F. Madhavi	ZPSS (Boys) Kaganaganur	9959619176	-	[Signature]	Need more programs.
7	P. Sarinani	B.B.H.S	6303081124	1	[Signature]	very useful for students
8	M. Thirupataiah	ZPSS PP SKZR	9182493690	1	[Signature]	circuits kani avudu kani avudu Explanation top paper in 2019 2019 avudu avudu.
9	K. KRISHNA	ZPSS PP SKZR	8341066579	-	[Signature]	
10	p. parumala	ZPSS (G) Sirsilk	-	+	[Signature]	Useful to student
11	B. Venugopal Rao	Kanuvu S. W. No. 14 SKM	9866744604	1	[Signature]	we will to student.
12	K. Roopakala	ZPSS (CB) SKZR	9440513592	1	[Signature]	very use ful for student
13	N. Vijayalaxmi	ZPSS (CB) SKZR	9490005649	1	[Signature]	Useful students

References

- 01) www.google.com
- 02) Komaram Bheem - Asifabad Dist website
- 03) Robotic Wikipedia
- 04) PPT of ICPS Division DST New Delhi
- 05) Robotics Fundamental concepts and analysis by ashitava ghosal
- 06) Make your First Robot by Vineesh kumar KK
- 07) How to make a Robot by Gordon mccomb
- 08) Discover the Science and Teachnology of the Future by Kathyceceri

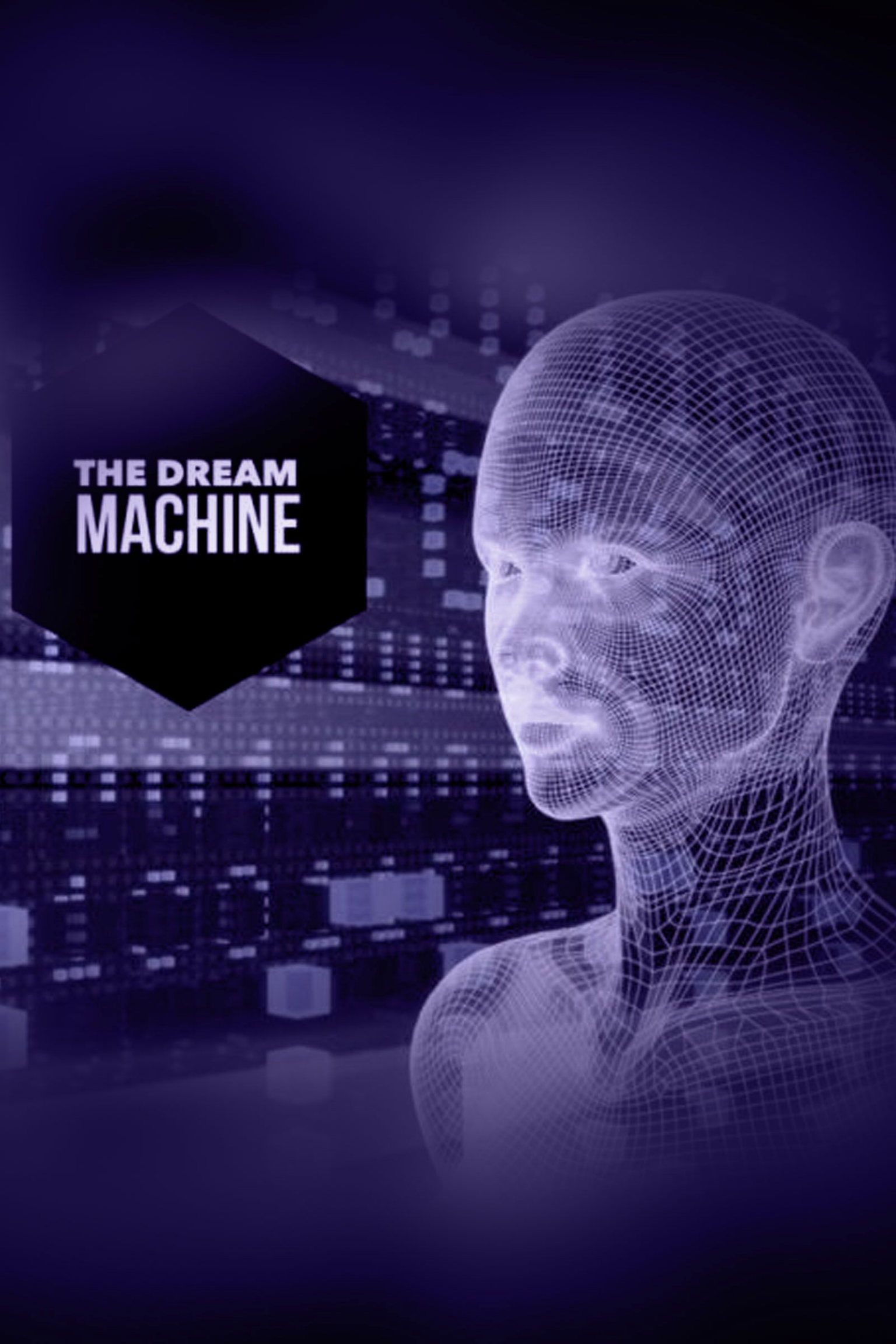
A wireframe human head and neck, rendered in a light blue color, is shown in profile, facing left. The background is a dark blue gradient with a grid of glowing white and light blue data points, creating a digital or futuristic atmosphere. A black hexagonal shape is overlaid on the left side of the image, containing the text "THE DREAM MACHINE" in white, bold, uppercase letters.

**THE DREAM
MACHINE**